

Cast Stone ***Standard Products***



Contents

Cast Stone Introduction	3
How to Order	4
Standard Colors	5
Standard Connection Hardware	5
Water Tables	6-7
Bands	8-9
Window Sills	10-13
Window Surrounds	14-15
Door Surrounds	16-17
Heads	18-19
Jack Arches	20-21
Keystones	22-23
Quoins	24-25
Copings	26-27
Pier Caps	28-29
Balls	30-31
Accents	32-33
Address Stones	34-35
Baluster & Rail Systems	36-39
Fireplace Surrounds	40-41
Custom Pieces	42
Terms and Conditions	43



777 Edwards Road
Dubuque, IA 52003-8500
563.556.0535
800.992.9323
Fax: 563.556.8906

Our Reputation is Cast in **Every Stone.**

Since Jim Edwards founded Edwards Cast Stone Company in 1964, the cornerstone of the family owned business has been integrity. As an industry leader in the field of cast stone, we offer you a quality product, superior shop drawings, reliable service and on time delivery.



Our 44,000 square foot state-of-the-art facility produces both wet and dry cast stone daily. Edwards Cast Stone offers an extensive choice of standard and custom colors and shapes, giving the designer a high degree of design freedom. Classic beauty and unmatched durability are incorporated into all of our products.



Any question from design and planning to shop production and field installation, Edwards Cast Stone has your solution. Our policy of prior approval of all plans and bids does more than solve problems, it helps prevent them. Our goal is your complete satisfaction and future consideration.



Here's How to Order

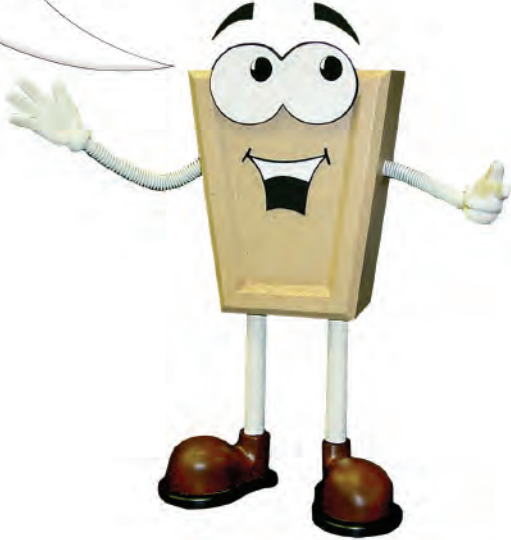

Ed C. Stone

ORDERING

Thank you for choosing Edwards Cast Stone Company for your Architectural Cast Stone needs. For your convenience we have set up each item to have its own page as an order form or ask your local dealer for an order form. Please copy desired page, fill out and fax or call your local Edwards Cast Stone Company dealer.

SHOP DRAWINGS

You may receive a shop drawing of your order for approval. If ordering a customized item some shop drawing cost may occur but will be included in a quote for your approval.

Sample Order Form

PROFILE	COLOR <i>See page 5.</i>	HEIGHT (Y)	LENGTH	END CONDITIONS <i>See page 6 for details.</i>						QTY
				FINISHED END		OUTSIDE CORNER		INSIDE CORNER		
				LEFT	RIGHT	LEFT	RIGHT	LEFT	RIGHT	
E101	Light Gray	15 5/8"	3' 11 5/8"	✓	—	—	—	—	—	12
E102	Buff	23 5/8"	3' 11 5/8"	—	✓	—	—	—	—	10
			3' 11 5/8"							
			3' 11 5/8"							

Contact: John Doe Company: Your Company Phone: (555) 555-1234 Fax: (555) 555-2345

CONNECTIONS

Edwards Cast Stone can provide anchor slots and dowel holes per your request at no additional charge. Edwards will also quote and supply loose connection hardware for your next project.

Standard Colors



Buff
Sample 23

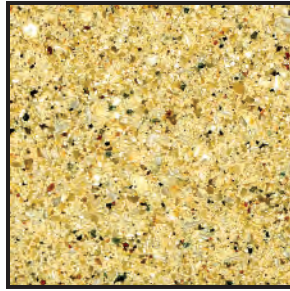

Tan
Sample 25



White
Sample 30

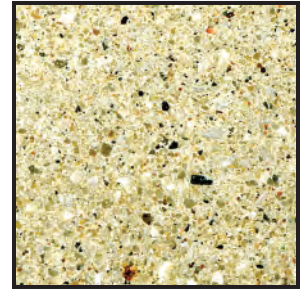

Light Gray
Sample 31

**Actual color may vary from sample shown.
Other custom colors are available.*

Standard Connection Hardware

Available upon request.

H101

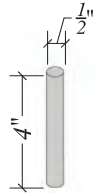

H102

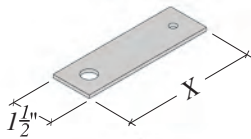

H103

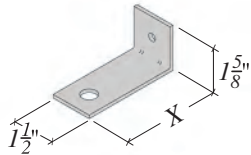

H104

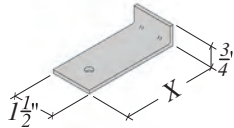

H105

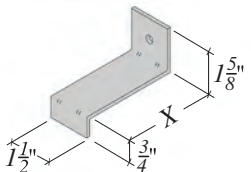

H106

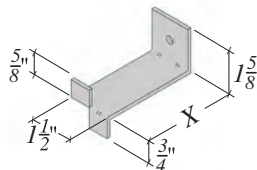

H107

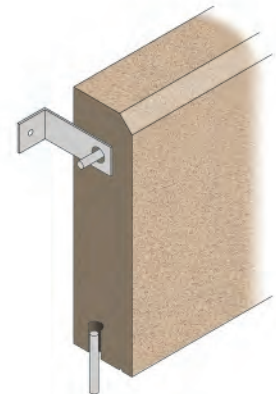
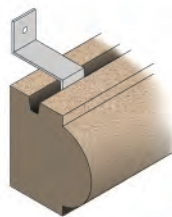
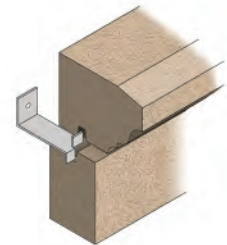
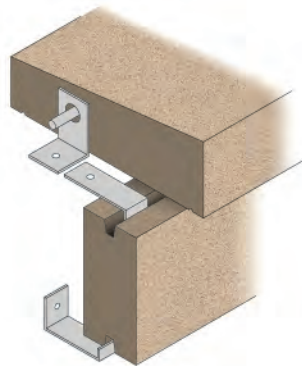
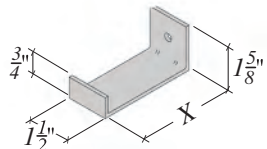

Connection Hardware

CONNECTION TYPE	LENGTH (X)	QTY
H102	5" EXAMPLE	12

Contact: _____ Company: _____ Phone: _____ Fax: _____

Cast Stone Water Tables



STANDARD END
(Unfinished)



FINISHED END
[@ Doors and Windows]

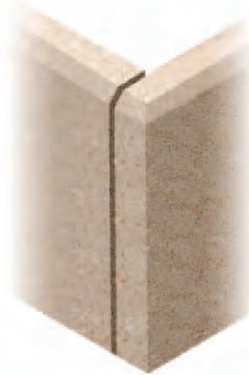

OUTSIDE CORNER



INSIDE CORNER

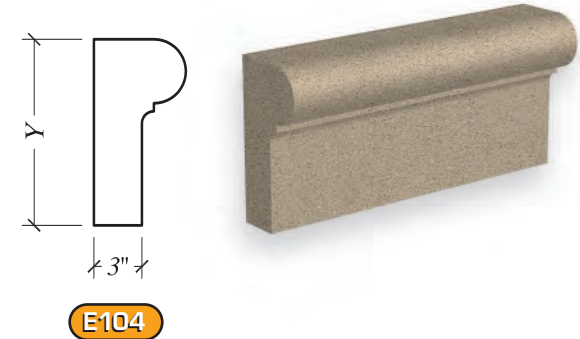
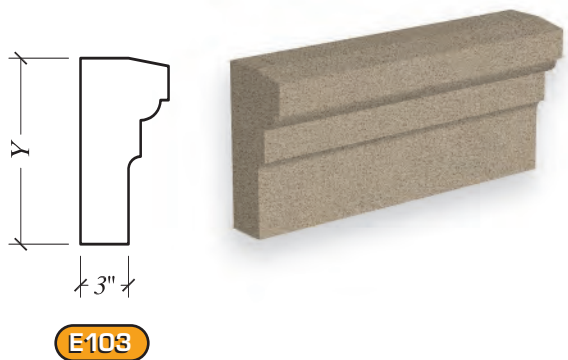

Standard Heights

(Y) = 11⁵/₈" , 15⁵/₈" , 23⁵/₈" or 31⁵/₈"

Water Tables

END CONDITIONS *See page 6 for details.*

PROFILE	COLOR <i>See page 5.</i>	HEIGHT (Y)	LENGTH	FINISHED END		OUTSIDE CORNER		INSIDE CORNER		QTY
				LEFT	RIGHT	LEFT	RIGHT	LEFT	RIGHT	
E101	Light Gray	15 5/8"	3' 11 5/8"	✓	—	—	—	—	—	12
			3' 11 5/8"							
			3' 11 5/8"							
			3' 11 5/8"							

Contact: _____ Company: _____ Phone: _____ Fax: _____

Cast Stone Bands



STANDARD END
(Unfinished)



FINISHED END
[@ Doors and Windows]
Left Shown



OUTSIDE CORNER
Left Shown



INSIDE CORNER

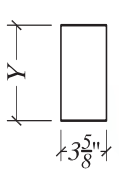

E201

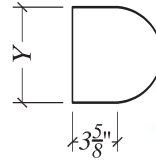

E206

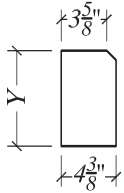

E202

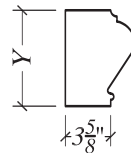

E207

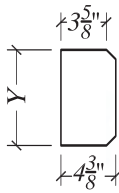

E203

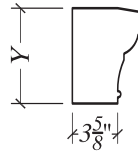

E208



E204

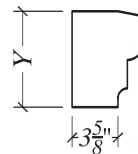

E209

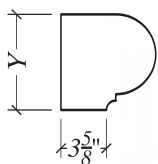

E205

Standard Heights

(Y) = 4 5/8", 5 5/8" or 7 5/8"

Bands

PROFILE	COLOR <i>See page 5.</i>	HEIGHT (Y)	LENGTH	END CONDITIONS <i>See page 8 for details.</i>						
				FINISHED END		OUTSIDE CORNER		INSIDE CORNER		QTY
				LEFT	RIGHT	LEFT	RIGHT	LEFT	RIGHT	
E201	Light Gray	5 5/8"	3' 11 5/8"	✓	—	—	—	—	—	12
			3' 11 5/8"							
			3' 11 5/8"							
			3' 11 5/8"							

Contact: _____ Company: _____ Phone: _____ Fax: _____

Cast Stone Window Sills



STANDARD END
(Unfinished)



FINISHED END



RETURN

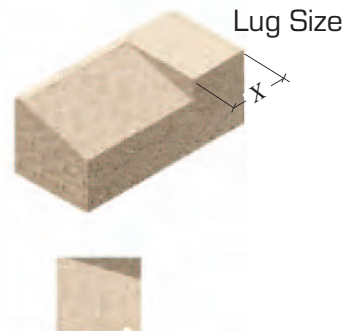

LUG END



Standard Heights

(Y) = 4^{5/8}" , 5^{5/8}" or 7^{5/8}"

Lug Size

(X) = 3^{5/8}" , 5^{5/8}" or 7^{5/8}"

Lug Sills

PROFILE	COLOR <i>See page 5.</i>	HEIGHT (Y)	LENGTH	END CONDITIONS <small>See page 10 for details.</small>						QTY
				FINISHED END		RETURN END		LUG END		
				LEFT	RIGHT	LEFT	RIGHT	LEFT	RIGHT	
E301	Light Gray	5 5/8"	3' 11 5/8"							12
			3' 11 5/8"							
			3' 11 5/8"							
			3' 11 5/8"							

Contact: _____ Company: _____ Phone: _____ Fax: _____

Cast Stone Window Sills

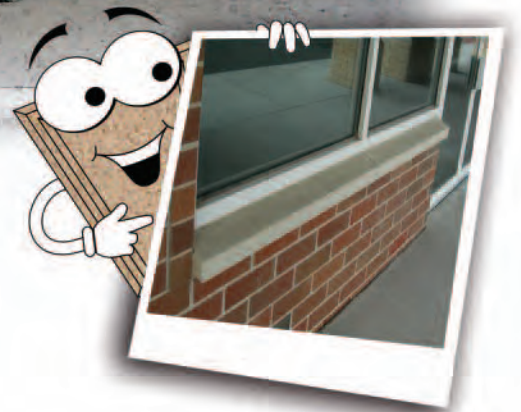

STANDARD END
(Unfinished)



FINISHED END



RETURN



Standard Heights

(Y) = 4⁵/₈" , 5⁵/₈" or 7⁵/₈"

Standard Sills

END CONDITIONS

See page 12 for details.

PROFILE	COLOR <i>See page 5.</i>	HEIGHT (Y)	LENGTH	FINISHED END		RETURN END		QTY
				LEFT	RIGHT	LEFT	RIGHT	
E308	Light Gray	5 5/8"	3' 11 5/8"	—	—	✓	—	12
			3' 11 5/8"					
			3' 11 5/8"					
			3' 11 5/8"					

Contact: _____ Company: _____ Phone: _____ Fax: _____

Cast Stone Window Surrounds

Window Surround Combinations

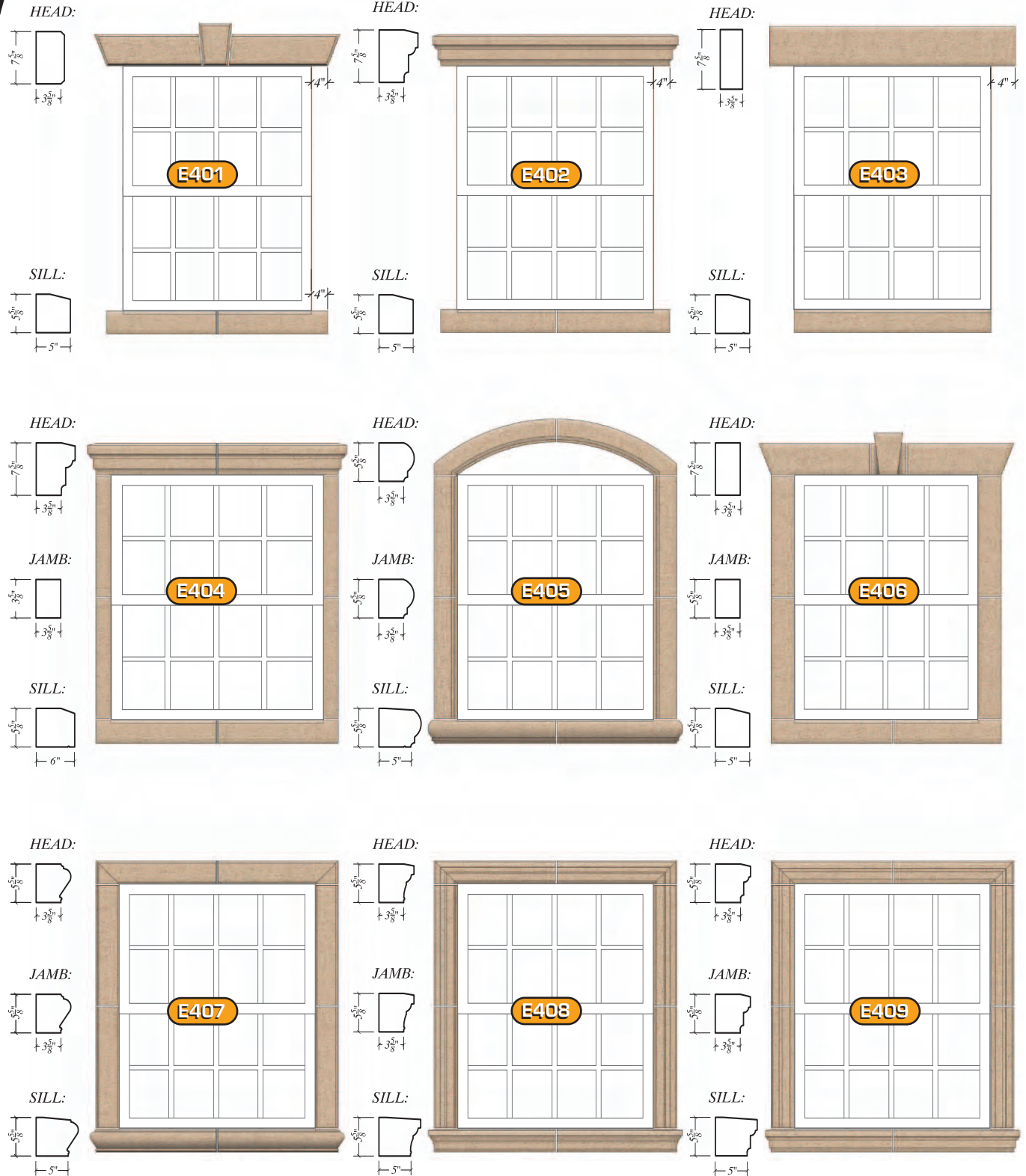

Keystones can be added to any window surround.
See page 23 for keystones.

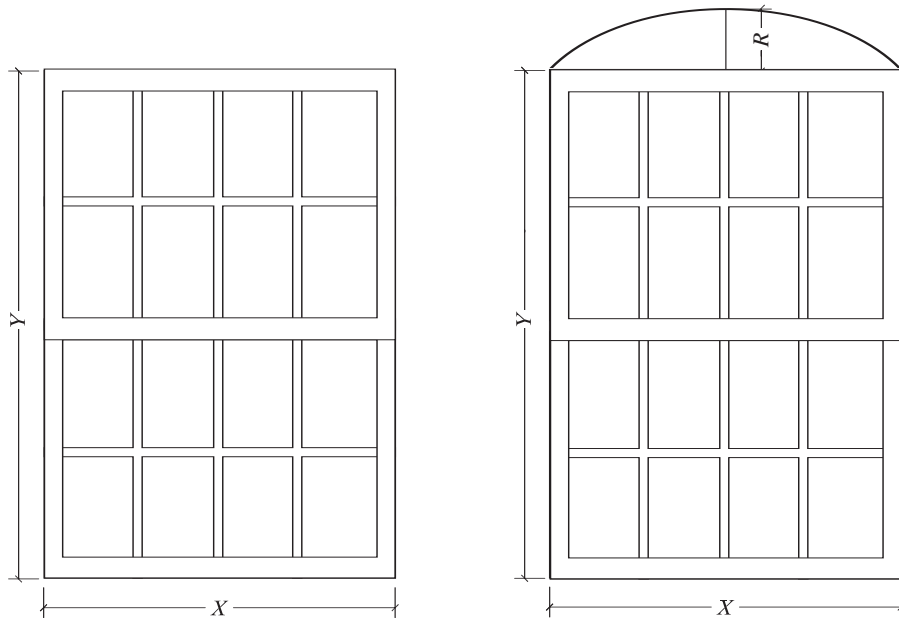

Please give measurements of actual window only. Not rough opening.

Standard Window Surround

Radius Window Surround

PROFILE SET	COLOR <i>See page 5.</i>	WINDOW OPENING		KEYSTONE <i>See page 23.</i>	QTY
		HEIGHT (Y)	WIDTH (X)		
<i>E401</i>	<i>Light Gray</i>	<i>72"</i>	<i>48"</i>	<i>E807</i>	<i>12</i>

PROFILE SET	COLOR <i>See page 5.</i>	WINDOW OPENING			KEYSTONE <i>See page 23.</i>	QTY
		HEIGHT (Y)	WIDTH (X)	RISE (R)		
<i>E406</i>	<i>Light Gray</i>	<i>72"</i>	<i>48"</i>	<i>12"</i>	<i>E807</i>	<i>12</i>

Contact: _____ Company: _____ Phone: _____ Fax: _____

Cast Stone Door Surrounds

Door Surround Combinations



Keystones can be added to any door surround.
See page 23 for keystones.

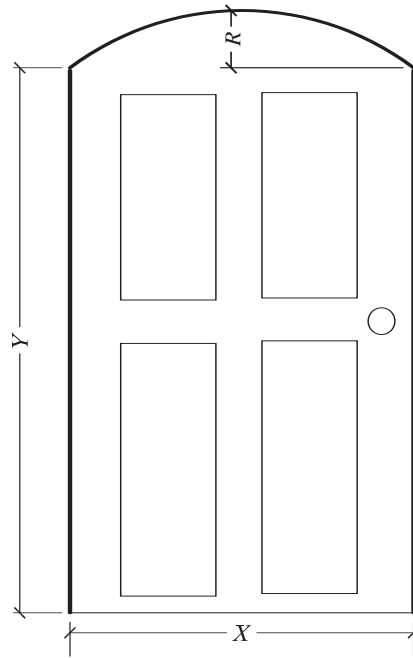
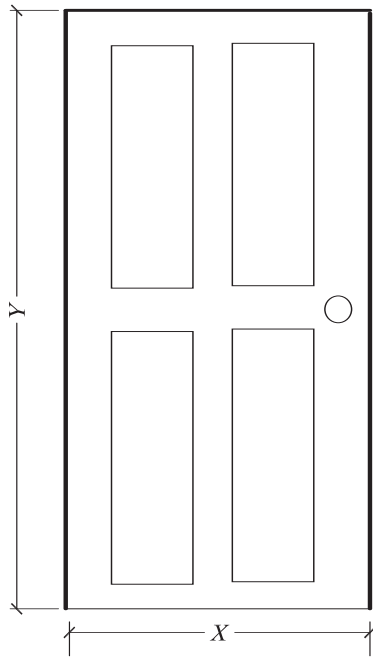

Standard Door Surround

DOOR OPENING

PROFILE SET	COLOR <i>See page 5.</i>	HEIGHT (Y)	WIDTH (X)	KEYSTONE <i>See page 23.</i>	QTY
<i>E501</i>	<i>Light Gray</i>	<i>72"</i>	<i>48"</i>	<i>E807</i>	<i>12</i>

Radius Door Surround

DOOR OPENING

PROFILE SET	COLOR <i>See page 5.</i>	HEIGHT (Y)	WIDTH (X)	RISE (R)	KEYSTONE <i>See page 23.</i>	QTY
<i>E506</i>	<i>Light Gray</i>	<i>72"</i>	<i>48"</i>	<i>12"</i>		<i>12</i>

Contact: _____ Company: _____ Phone: _____ Fax: _____



STANDARD END
(Unfinished)



FINISHED END



RETURN

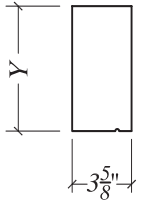

E601

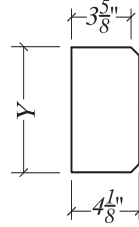

E602

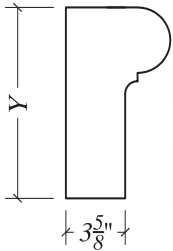

E603

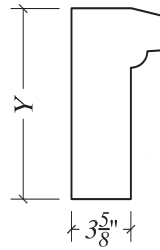
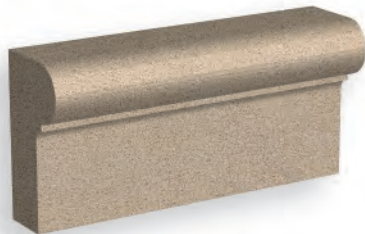

E604



Heads

(Y) = 7 5/8" or 11 5/8"

END CONDITIONS

See page 18 for details.

PROFILE	COLOR <i>See page 5.</i>	HEIGHT (Y)	LENGTH	FINISHED END		RETURN END		QTY
				LEFT	RIGHT	LEFT	RIGHT	
E601	Light Gray	7 5/8"	3' 11 5/8"			✓		12
			3' 11 5/8"					
			3' 11 5/8"					
			3' 11 5/8"					

Contact: _____ Company: _____ Phone: _____ Fax: _____

Cast Stone
Jack Arches



**Cast Stone adds elegance
to conventional windows.**

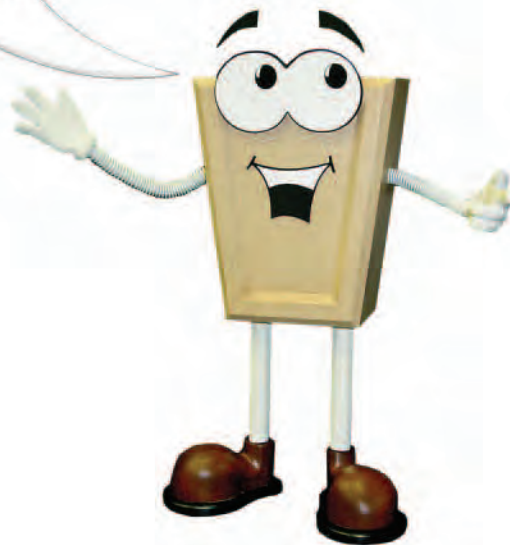



E701

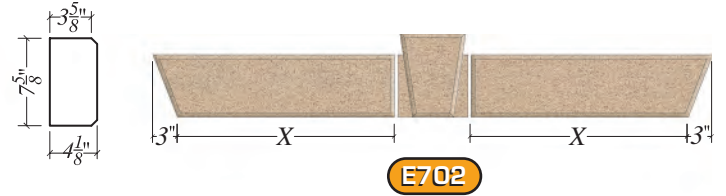

E702



E703

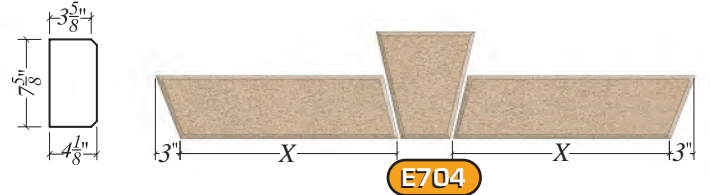

E704



E705

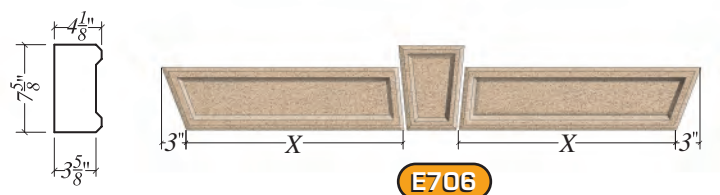

E706



E707



E708

Jack Arches

PROFILE	COLOR <i>See page 5.</i>	LENGTH (X)	QTY
E701	Light Gray	3'-0"	12

If Length (X) exceeds 4'-0", two pieces will be needed.

Contact: _____ Company: _____ Phone: _____ Fax: _____



**Keystones add distinction
to your project.**

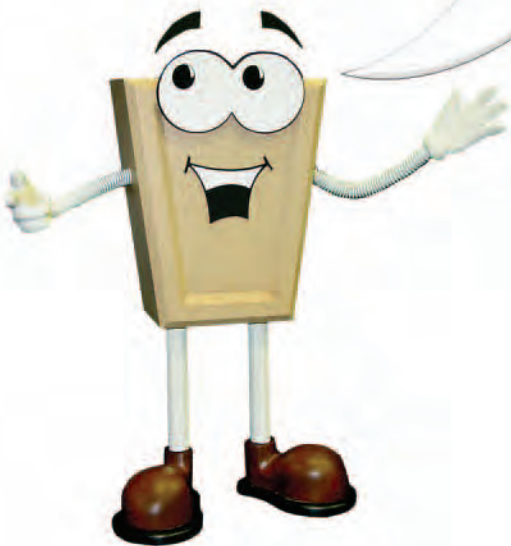

E801

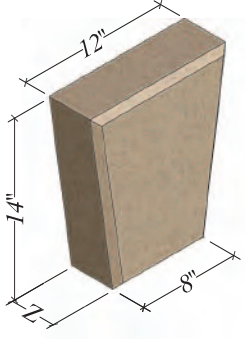

E802

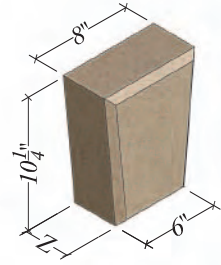

E803

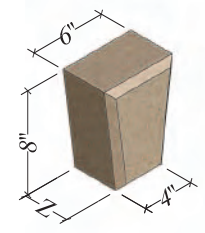

E804

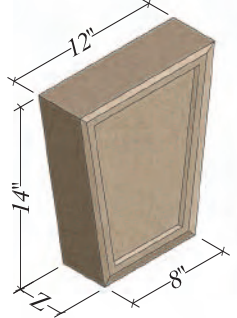

E805

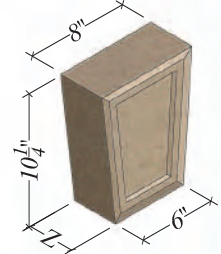

E806

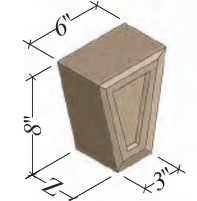

E807

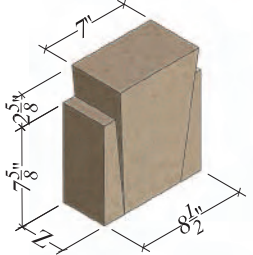

E808

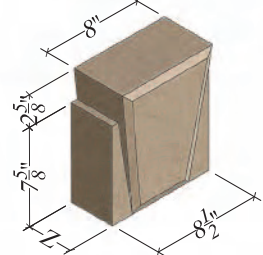

E809

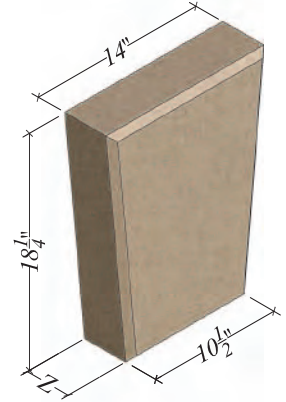

E810

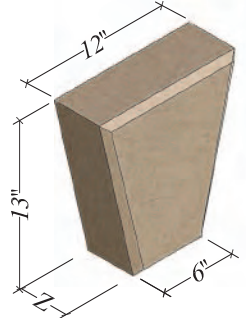

E811

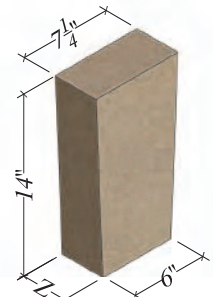

E812

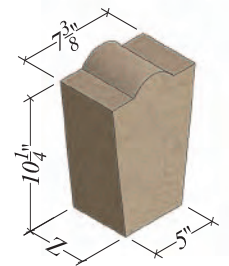

Keystones

PROFILE	COLOR <i>See page 5.</i>	DEPTH (Z)	QTY
E801	Light Gray	4"	12

(Z) = 4" or 6"

Contact: _____ Company: _____ Phone: _____ Fax: _____

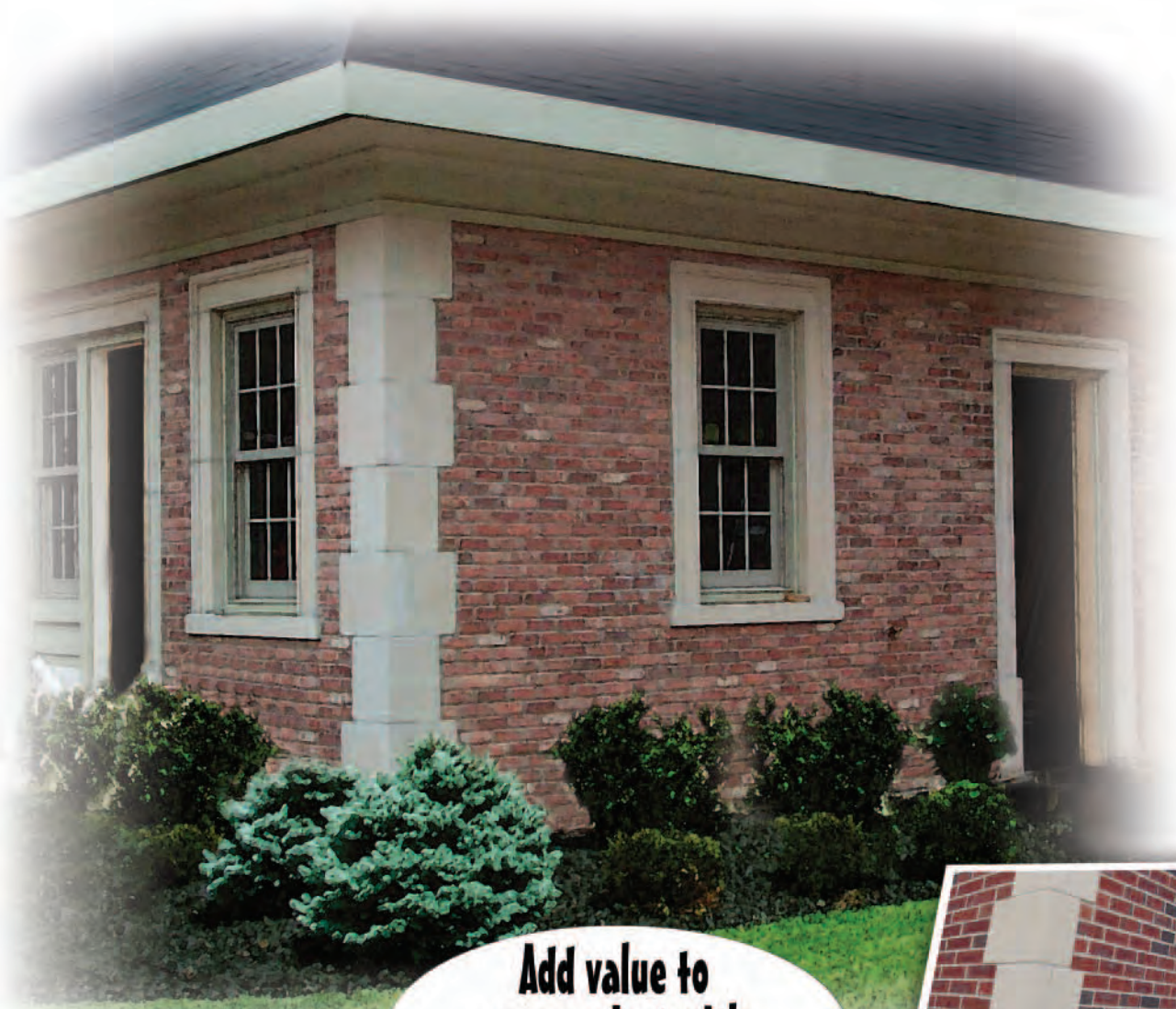

**Add value to
your project with
Edwards quoins.**

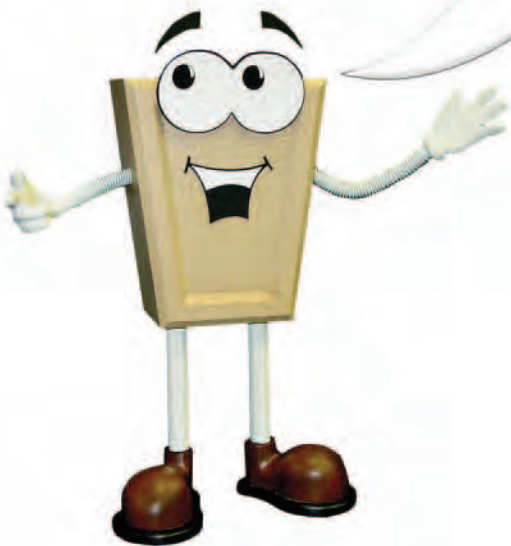

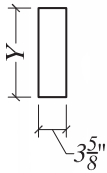

E901

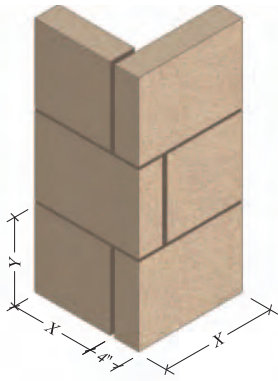

STRAIGHT

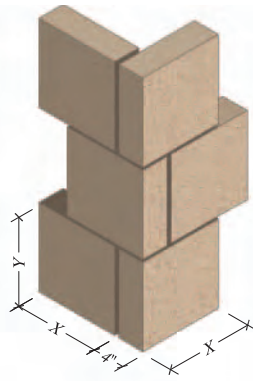

STAGGERED

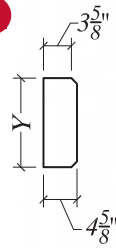

E902

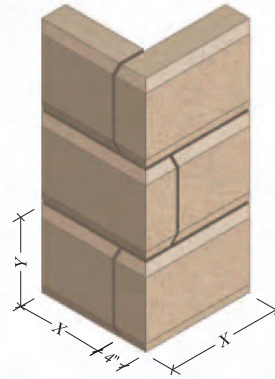

STRAIGHT

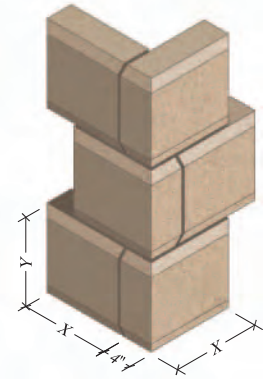

STAGGERED

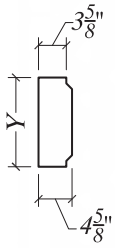

E903

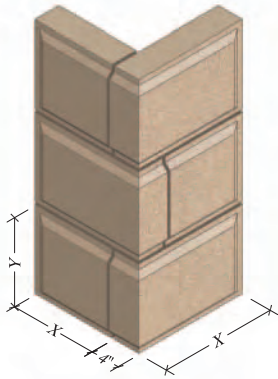

STRAIGHT

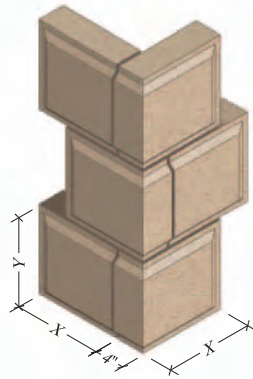

STAGGERED

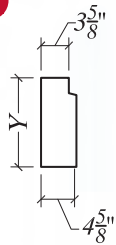

E904

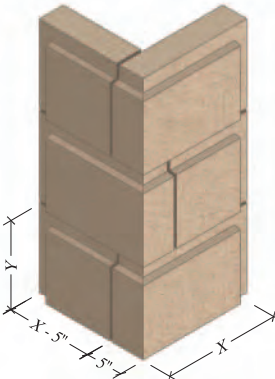

STRAIGHT

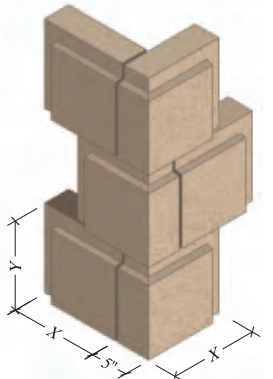

STAGGERED

Standard Heights

(Y) = 10 1/4", 13" or 15 5/8"

Standard Lengths

(X) = 7 5/8", 11 5/8" or 15 5/8"

Quoins

PROFILE SET	COLOR <i>See page 5.</i>	HEIGHT (Y)	LENGTH (X)	STRAIGHT	STAGGERED	REQ'D SETS
<i>EXAMPLE</i> E901	Light Gray	10 1/4"	15 5/8"	—	✓	12

Contact: _____ Company: _____ Phone: _____ Fax: _____

Cast Stone Copings



STANDARD END
(Unfinished)



FINISHED END
(Return Profile)



OUTSIDE CORNER



INSIDE CORNER

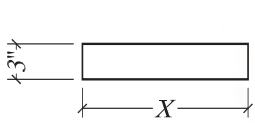

E1001

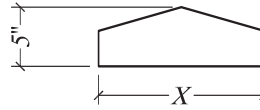

E1002

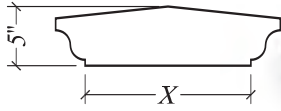

E1003

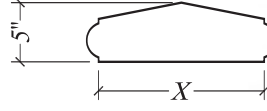

E1004

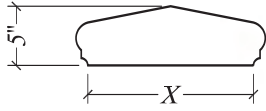
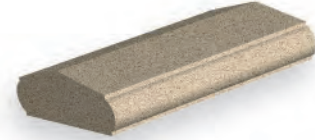

E1005

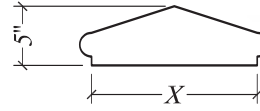
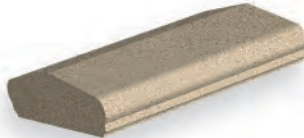

E1006

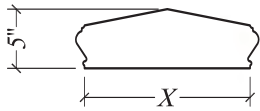

E1007

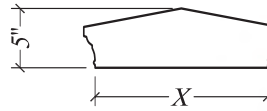
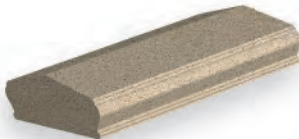

E1008

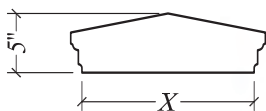

E1009



Standard Widths

(X) = 8", 10", 12", 14", 16", 18" or 24"

Coping

END CONDITIONS See page 26 for details.

PROFILE	COLOR <i>See page 5.</i>	WIDTH (X)	LENGTH	END CONDITIONS						QTY
				FINISHED END		OUTSIDE CORNER		INSIDE CORNER		
				LEFT	RIGHT	LEFT	RIGHT	LEFT	RIGHT	
E1001	Light Gray	12"	3' 11 5/8"	✓	—	—	—	—	—	12
			3' 11 5/8"							
			3' 11 5/8"							
			3' 11 5/8"							

Contact: _____ Company: _____ Phone: _____ Fax: _____

Cast Stone Pier Caps

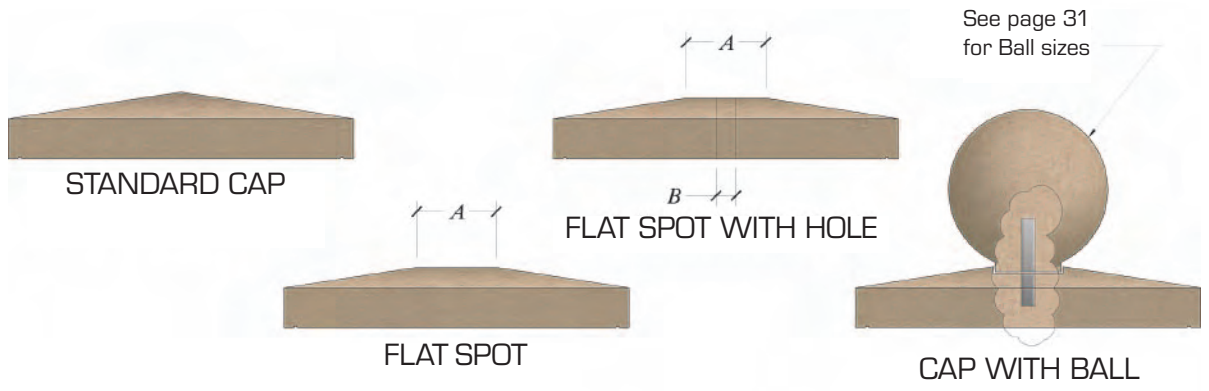
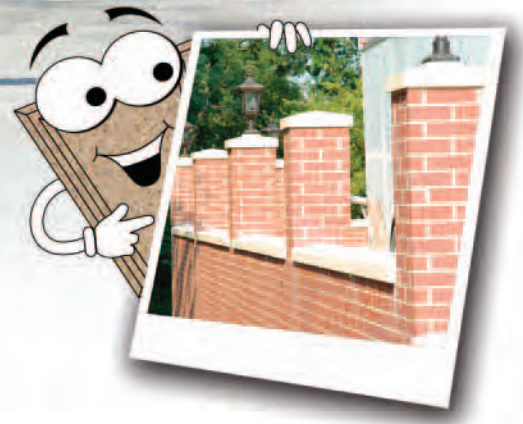

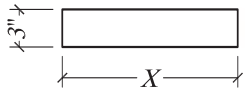

E1101

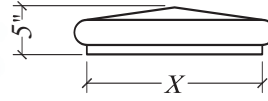

E1105

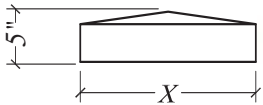
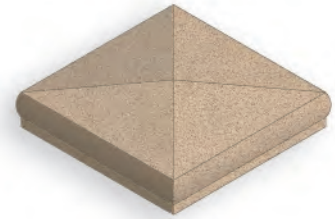

E1102

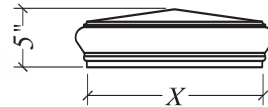
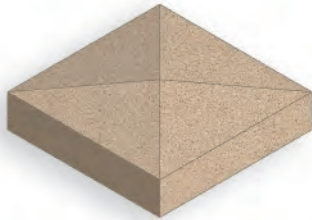

E1106

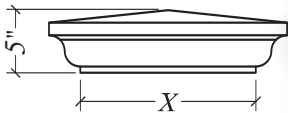
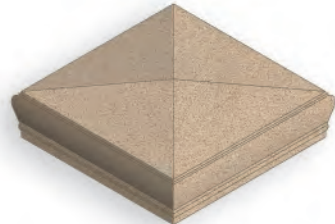

E1103

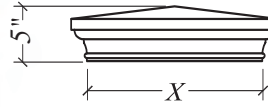

E1107

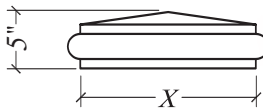
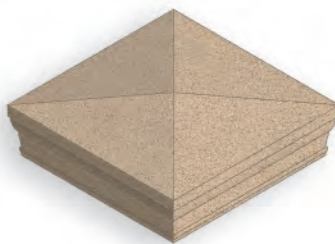

E1104

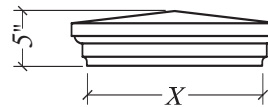

E1108

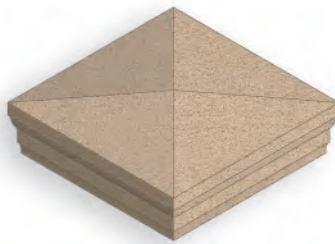

Standard Widths

(X) = 14", 18", 22", 24", 26", 28", 30", 32" or 36"

Pier Caps

PROFILE	COLOR <i>See page 5.</i>	WIDTH (X)	QTY
E1101	Light Gray	14"	12

SPECIAL CONDITIONS *See page 28 for details.*

BALL SIZE <i>See page 31.</i>	FLAT SPOT <i>A = Inches Squared</i>	Hole Size <i>B = Diameter</i>
12"	EXAMPLE	—

Contact: _____ Company: _____ Phone: _____ Fax: _____



Any size ball can be attached to any size Pier Cap from page 29.

* Lifting insert holes to be patched by others.

Sphere Weight

6" = 10.5 lbs.
8" = 33.0 lbs.
10" = 45.0 lbs.
12" = 78.0 lbs.
16" = 186.0 lbs.
24" = 643.5 lbs.
30" = 1,227.0 lbs.
36" = 2,121.0 lbs.

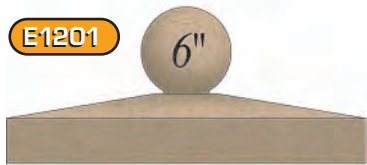

Balls shown on a 24" pier cap.
(Pier cap sold separately. See page 29.)

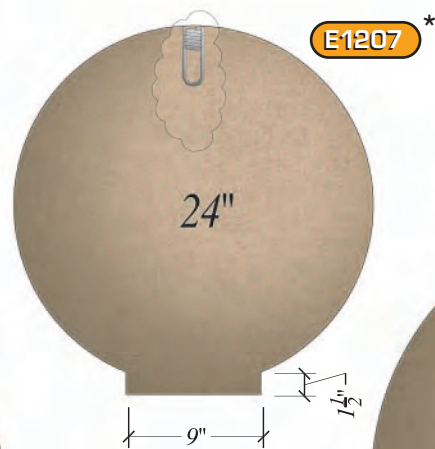

Balls

PROFILE	COLOR <i>See page 5.</i>	QTY
E1201	Light Gray	12

Contact: _____ Company: _____ Phone: _____ Fax: _____



Use accents to emphasize
the beauty of your
next project.



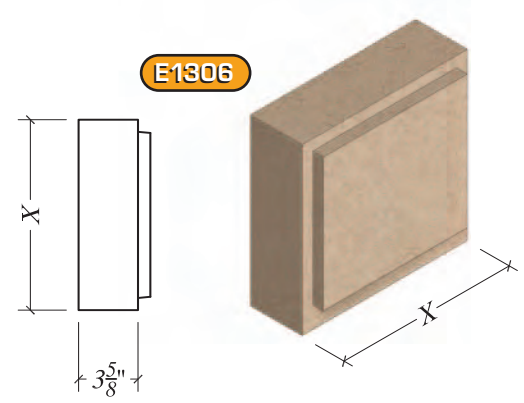
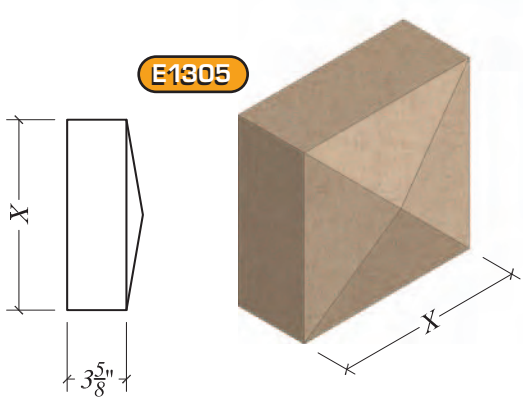
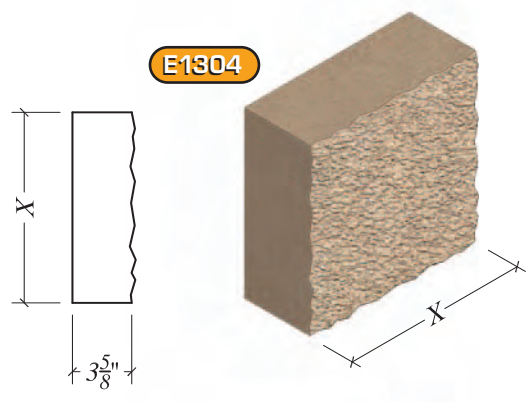
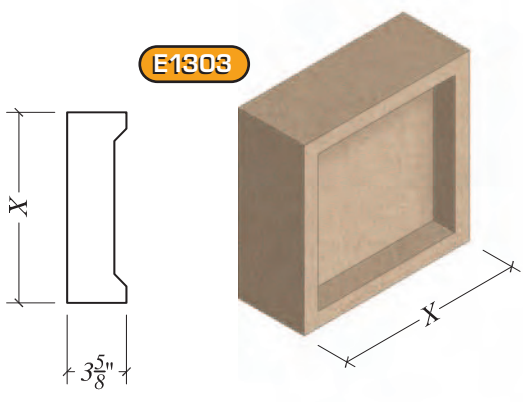
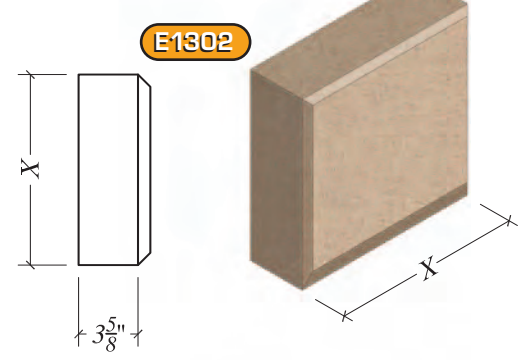
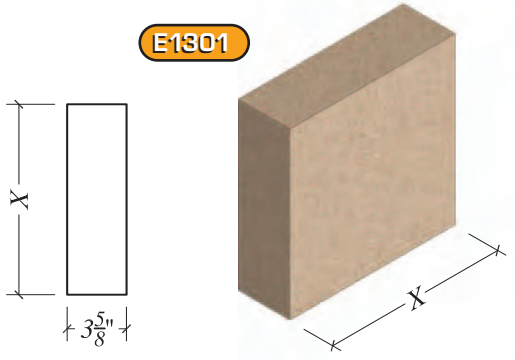

Accents

PROFILE	COLOR <i>See page 5 .</i>	LENGTH/HEIGHT (X)	QTY
E1301	Light Gray	15 5/8"	12

**(X) = 7⁵/₈" , 10¹/₄" , 13" ,
15⁵/₈" , 23⁵/₈" or 31⁵/₈"**

Contact: _____ Company: _____ Phone: _____ Fax: _____

Cast Stone Address Stones



Font Style

Commercial Script
1234567890

Arrus Blk BT
1234567890

Old English
1234567890

Agarmond Bold Italic
1234567890

Baskerville BT
1234567890

Palatino Bold Italic
1234567890

Americana XBdCnB
1234567890

BerkOldSty BK BT
1234567890

Perpetua Bold Italic
1234567890

Arial
1234567890

Century Bold Italic
1234567890

Times New Roman
1234567890

Borders



STYLE 1



STYLE 2



STYLE 3



STYLE 4



STYLE 5



STYLE 6

Stone Series

"C" SERIES

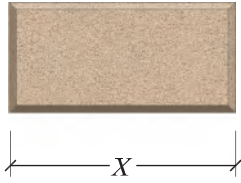
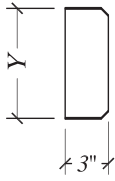

"R" SERIES

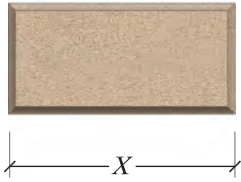
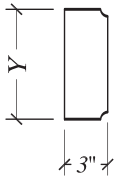

"RCD" SERIES

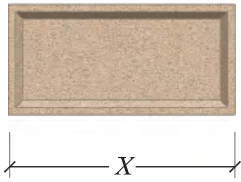
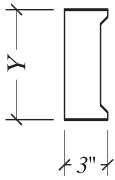

"S" SERIES

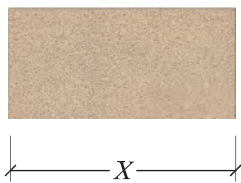
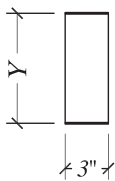

STONE SERIES	HEIGHT (Y)	WIDTH (X)	BORDER AVAILABLE
C1	7 5/8"	7 5/8"	✓
C2	7 5/8"	11 5/8"	✓
C3	7 5/8"	15 5/8"	✓
C4	7 5/8"	19 5/8"	✓
C5	7 5/8"	23 5/8"	✓
C6	9 3/8"	15 5/8"	✓
R1	7 5/8"	7 5/8"	✓
R2	7 5/8"	11 5/8"	✓
R3	7 5/8"	15 5/8"	✓
R4	7 5/8"	19 5/8"	✓
R5	7 5/8"	23 5/8"	✓
R6	9 3/8"	15 5/8"	✓
RCD1	7 5/8"	7 5/8"	N/A
RCD2	7 5/8"	11 5/8"	N/A
RCD3	7 5/8"	15 5/8"	N/A
RCD4	7 5/8"	19 5/8"	N/A
RCD5	7 5/8"	23 5/8"	N/A
RCD6	9 3/8"	15 5/8"	N/A
RCD7	9 1/4"	17"	N/A
RCD8	10 3/4"	15 5/8"	N/A
RCD9	16"	17"	N/A
S1	5"	7 5/8"	✓
S2	5"	11 5/8"	✓
S3	5"	15 5/8"	✓
S4	5"	19 5/8"	✓
S5	5"	23 5/8"	✓
S6	7 5/8"	7 5/8"	✓
S7	7 5/8"	11 5/8"	✓
S8	7 5/8"	15 5/8"	✓
S9	7 5/8"	19 5/8"	✓
S10	7 5/8"	23 5/8"	✓
S11	9 3/8"	11 5/8"	✓
S12	9 3/8"	15 5/8"	✓

BORDER OPTIONS See page 34 for details.

FONT STYLES See page 34 for details.

Address Stones

STONE SERIES	HOUSE NUMBER	STONE COLOR		FONT STYLE	FONT COLOR		BORDER STYLE (1-6)	QTY
		LT. GRAY	BUFF		BLACK	BROWN		
C1	1234	✓	EXAMPLE	CENTURY	✓	EXAMPLE	2	1

Contact: _____ Company: _____ Phone: _____ Fax: _____

Cast Stone Baluster & Rail Systems

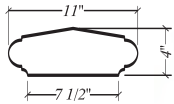

E1401

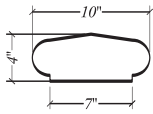

E1402



E1410



E1411



E1412

E1413 (STAIR BALUSTER)

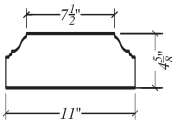

E1420

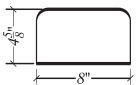

E1421



Top Rail

See pages 36-37 for examples.

PROFILE	COLOR <i>See page 5.</i>	LENGTH	QTY
E1401	Light Gray	3' 11 ⁵ / ₈ "	12
		3' 11 ⁵ / ₈ "	
		3' 11 ⁵ / ₈ "	
		3' 11 ⁵ / ₈ "	

Baluster

See pages 36-37 for examples.

PROFILE	COLOR <i>See page 5.</i>	QTY
E1410	Light Gray	12

Bottom Rail

See pages 36-37 for examples.

PROFILE	COLOR <i>See page 5.</i>	LENGTH	QTY
E1420	Light Gray	3' 11 ⁵ / ₈ "	12
		3' 11 ⁵ / ₈ "	
		3' 11 ⁵ / ₈ "	
		3' 11 ⁵ / ₈ "	

Contact: _____

Company: _____

Phone: _____

Fax: _____

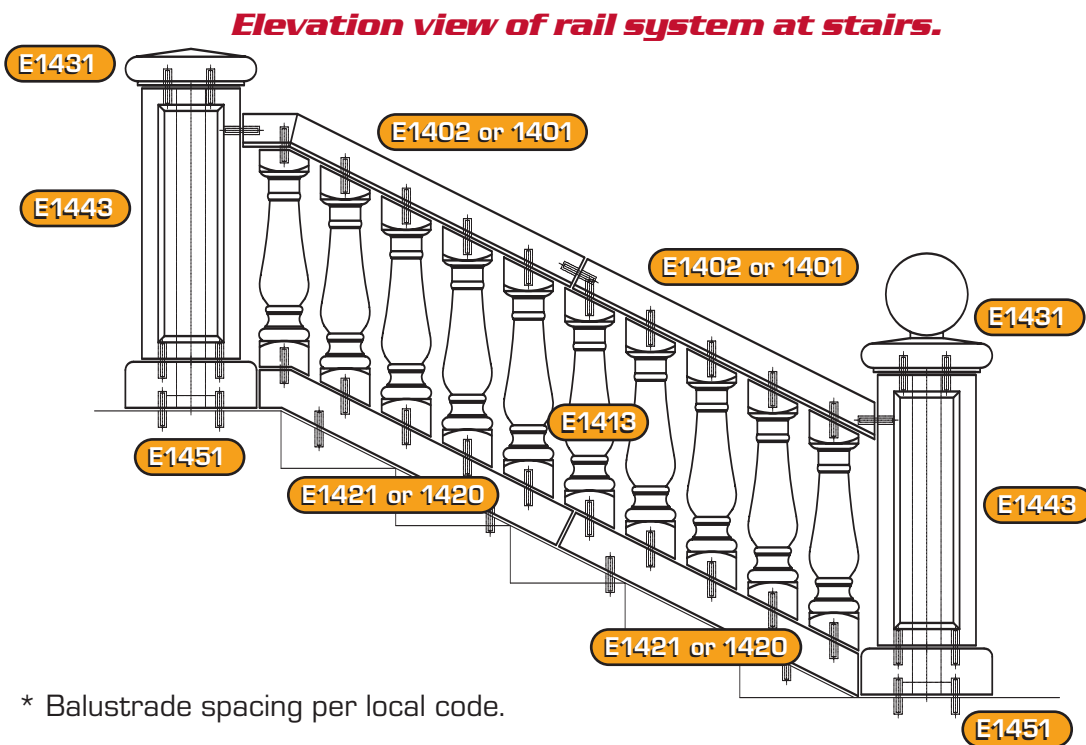
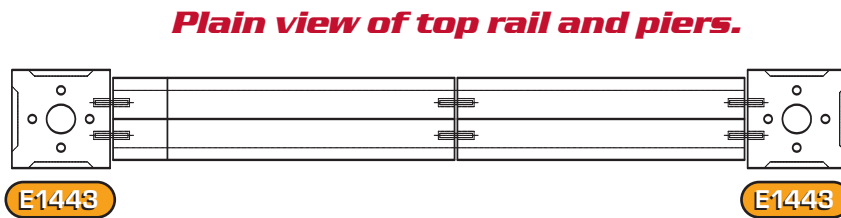
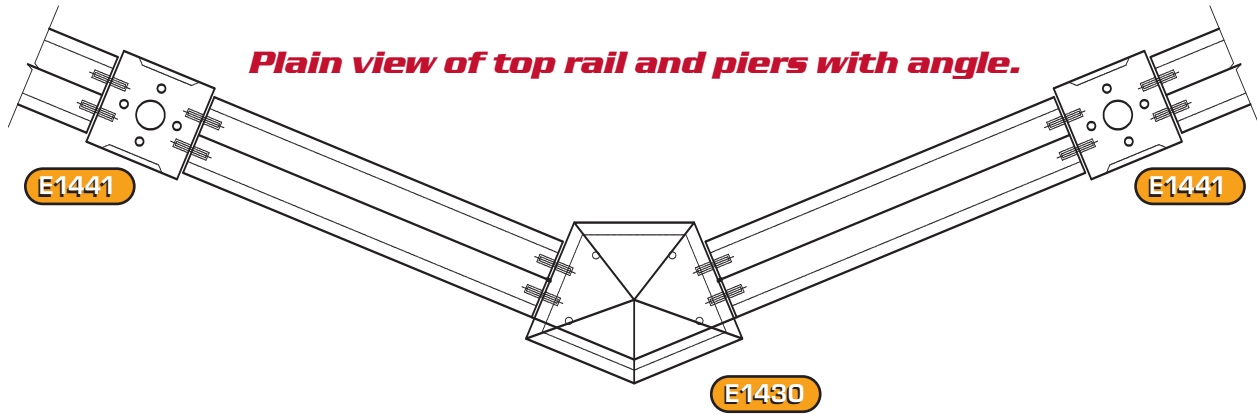

* Balustrade spacing per local code.

Cast Stone Baluster & Rail Systems



Plain view of top rail and piers.

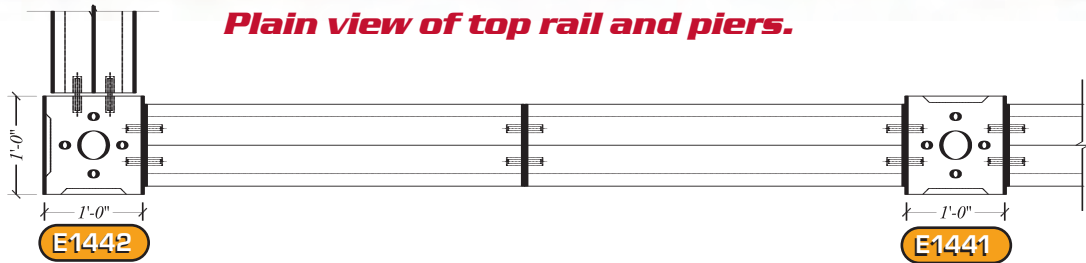

Plain view of top rail and brick piers.

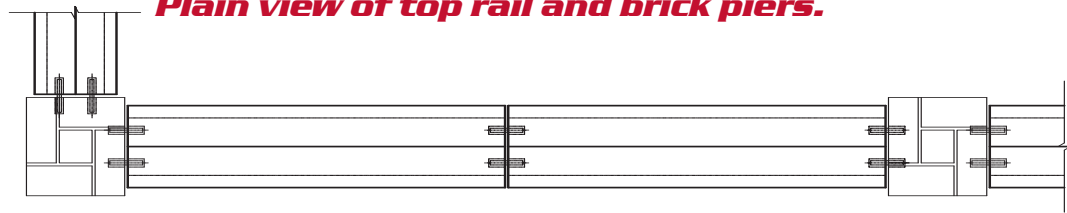

Elevation view of rail system with brick piers.

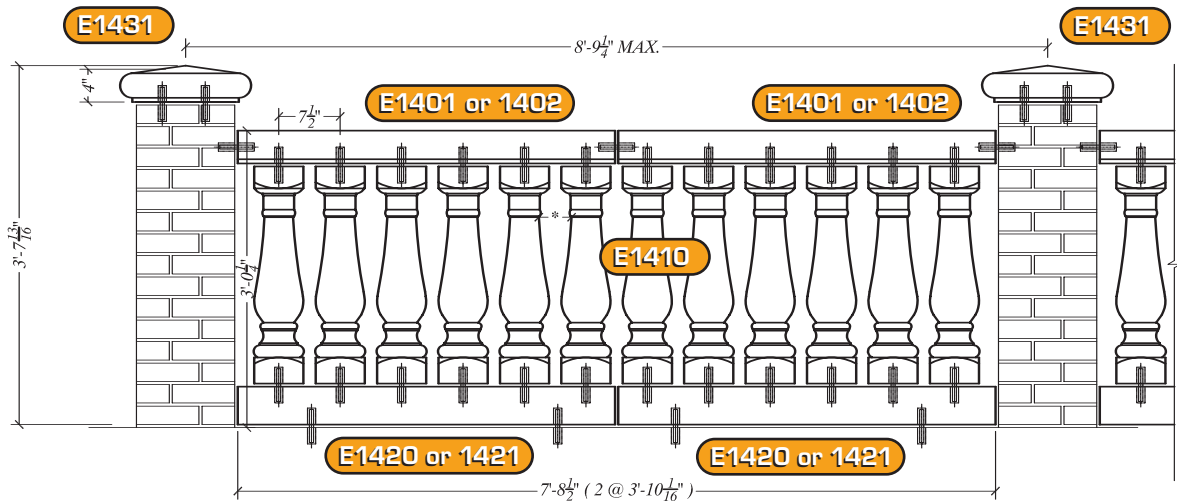

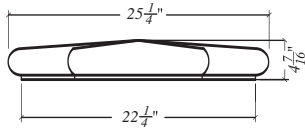

E1430

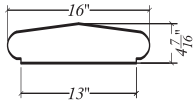

E1431

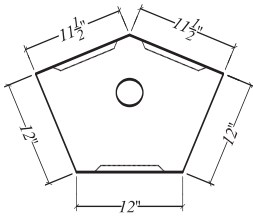

E1440

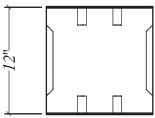
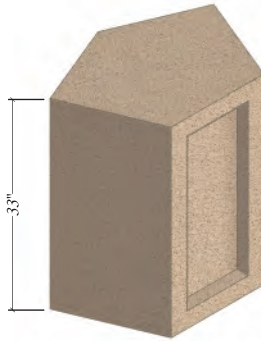

E1441

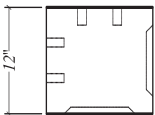

E1442

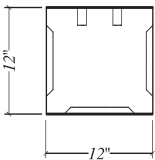

E1443

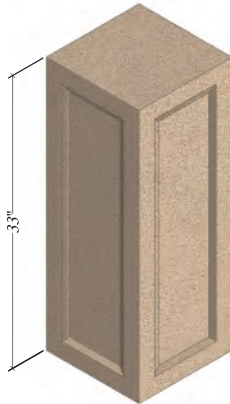

E1450

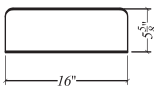
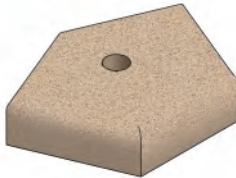
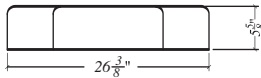

E1451

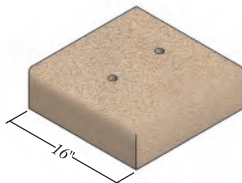

Pier Cap See pages 36-37 for examples.

PROFILE	COLOR <i>See page 5.</i>	QTY
E1430	Light Gray	12

Pier See pages 36-37 for examples.

PROFILE	COLOR <i>See page 5.</i>	QTY
E1440	Light Gray	12

Pier Base See pages 36-37 for examples.

PROFILE	COLOR <i>See page 5.</i>	QTY
E1450	Light Gray	12

Contact: _____ Company: _____ Phone: _____ Fax: _____

Cast Stone Fireplace Surrounds

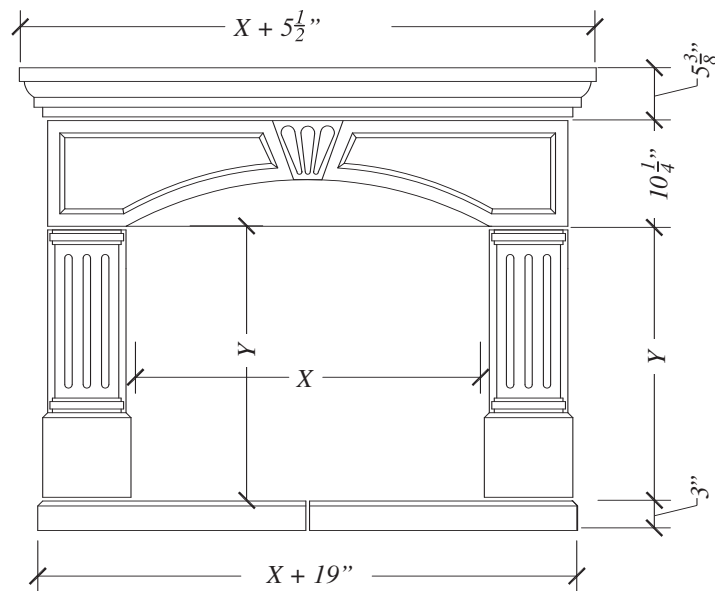



E1501



E1502



E1503

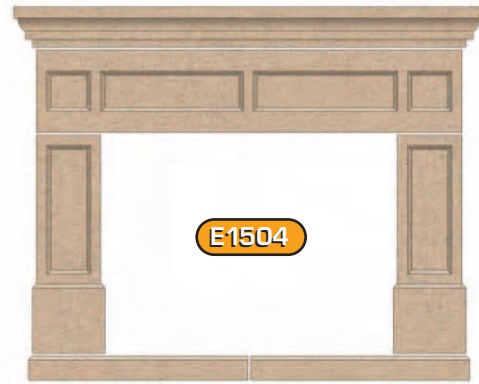

E1504



E1505

Fireplace Surrounds

PROFILE SET	COLOR <i>See page 5.</i>	FIRE BOX OPENING		QTY
		HEIGHT (Y)	WIDTH (X)	
<i>E401</i>	<i>Light Gray</i>	<i>40"</i>	<i>50"</i>	<i>1</i>

(Y) = 28" or 40"

(X) = 36" or 50"

Contact: _____ Company: _____ Phone: _____ Fax: _____

Custom Pieces

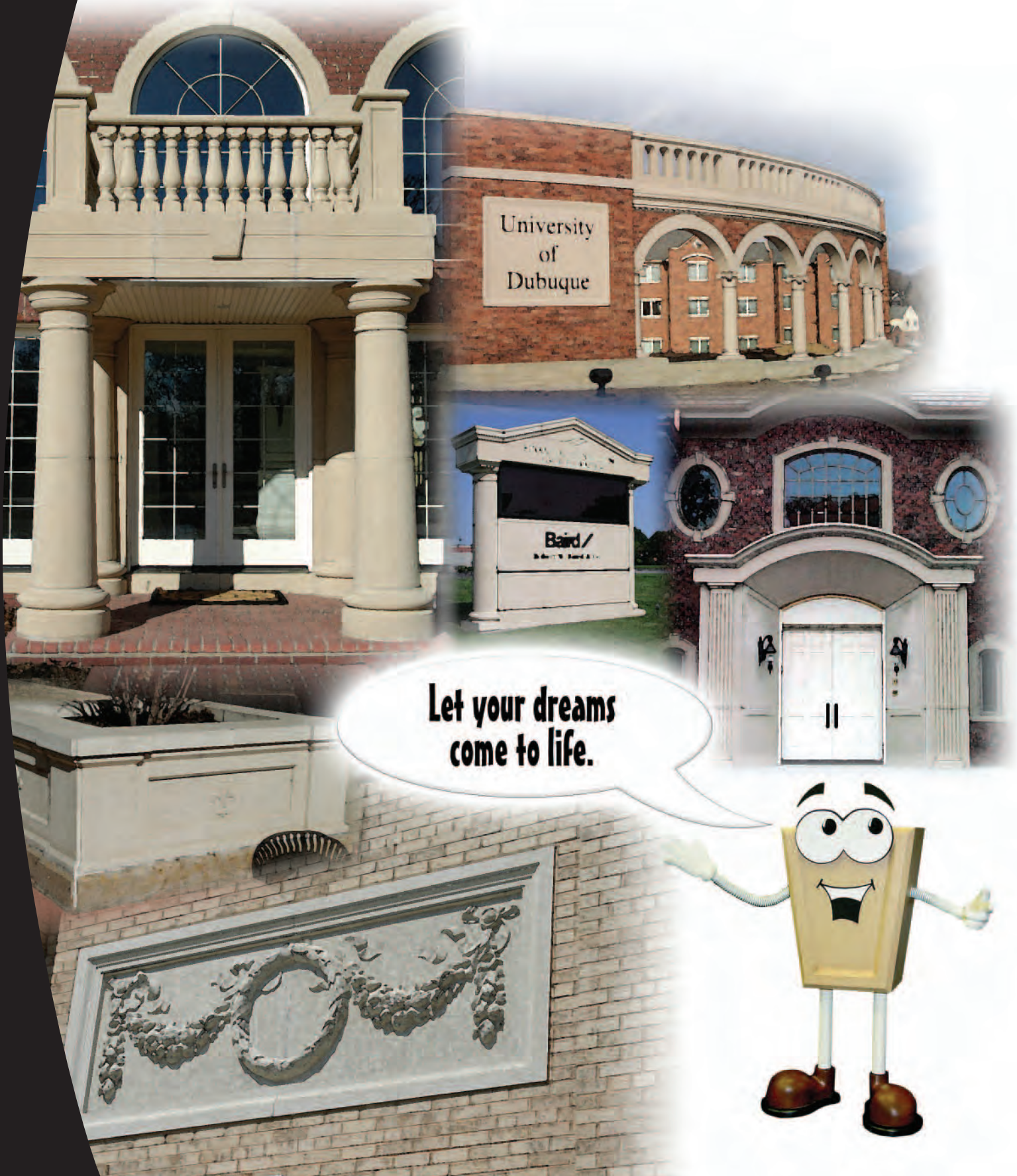

Let your dreams
come to life.

Terms & Conditions

EASE OF INSTALLATION

Edwards Cast Stone does not perform installation, but as an option does supply masonry hardware (see page 5). It is recommended that cast stone be installed by a stone mason or contractor experienced in stone setting. Edwards Cast Stone accepts no responsibility for installation or liability with regard to the use of outside contractors, or pieces damaged during the installation process.

CLEANING

Regardless of the degree of care exercised during construction, a final wash down will be needed and, normally, whatever is specified to clean the brickwork will adequately clean the cast stone. A variety of commercial cleaners are available and most contain detergents combined with mild solutions of phosphoric and/or meiotic acids. Cast Stone should be wet before applying any cleaner. Extreme care should be taken when applying acidic cleaners to areas where joints are left open or where sealant is used as jointing material. The sealant manufacturer should be contacted to ascertain compatibility with cleaning materials. Acids left behind the stone on masonry wythe may cause corrosion problems later on.

SHIPPING

Truckload quantities will have shrink wrapped wooden pallets loaded on standard flat bed trailers and shipped by independent trucking firms. Less than truckload quantities will be shipped via LTL carrier. The job or delivery site must be accessible.

RECEIVING

A forklift is required to unload all palletized cast stone. In all cases, it is the customer's responsibility to unload the material. Unloading time allowed is two (2) hours. Time spent unloading over two (2) hours will be billed at \$50.00 per hour.

INSPECTION

Pallets must be immediately inspected upon delivery for any damage. Any claim for damage must be noted on the freight bill, and a claim filed with the freight company. Any product defects must be reported in writing to Edwards Cast Stone within 24 hours of receiving the order. Installation of product constitutes acceptance.



What is Cast Stone?

Cast Stone is a high quality building material that simulates natural limestone. It is manufactured from graded aggregates, Portland cement, additives and color pigments.

Cast Stone is generally used as a masonry product, an architectural feature, trim, ornament, or facing for buildings and other structures.

Cast Stone can be made from white or grey cements, manufactured or natural sands, selected crushed stone or well graded natural gravel. Mineral coloring pigments are added to achieve the desired color and appearance. It is stronger and more weather resistant than natural stone and has a higher degree of versatility.

Cast Stone is an excellent replacement for natural cut limestone, brownstone, sandstone, bluestone, granite, slate, keystone, travertine and other natural building stones.

Technical Data:

Spec Section: 04720
Wet or Dry Cast Stone
6,500 minimum PSI
6% absorption or less
145 lbs./cu.ft.
All testing per ASTM C-1364
No air voids visible from 10 feet - Wet Cast
No air voids - Dry Cast
Wet cast stone and dry cast stone can be combined
Tooled edges for handling durability
Unlimited color selection
Most wet cast and dry cast colors can be matched on a project

777 Edwards Road
Dubuque, IA 52003-8500
563.556.0535
800.992-9323
Fax: 563.556.8906



Edwards
CAST STONE COMPANY

