

Panel Mouldings

8 Ft. Lengths

Measurements are approximate



PX103

PX103A

A = 7-1/2", B = 1-3/8", C = 1/2"

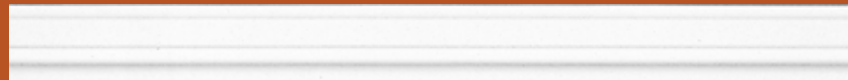
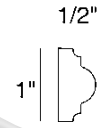
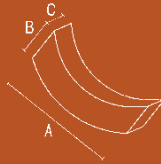

PX116

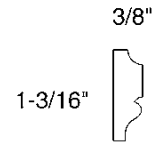

PX117

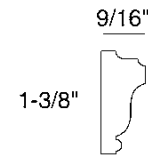

PX120

PX120A

A = 7-1/2", B = 2-1/4", C = 3/4"

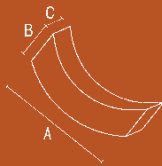

PX103

PX120

SX104



PX130

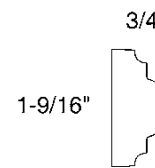

PX131

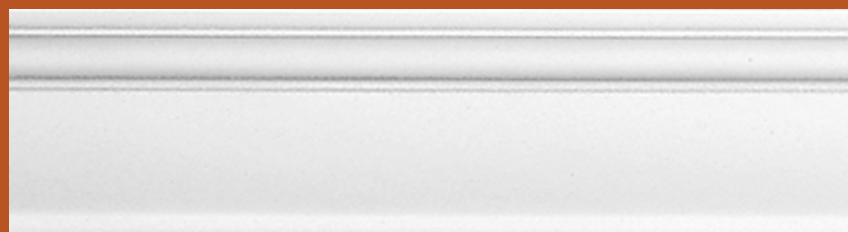
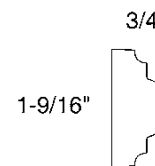

PX113

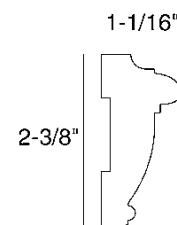

When mounting, if not nailing, it is recommended to use Orac DecoFix Pro. You must use Orac DecoFix Pro for all joints (see page 29).

Panel Mouldings

8 Ft. Lengths

Measurements are approximate

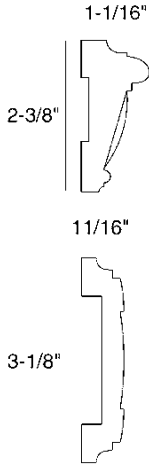

PX114

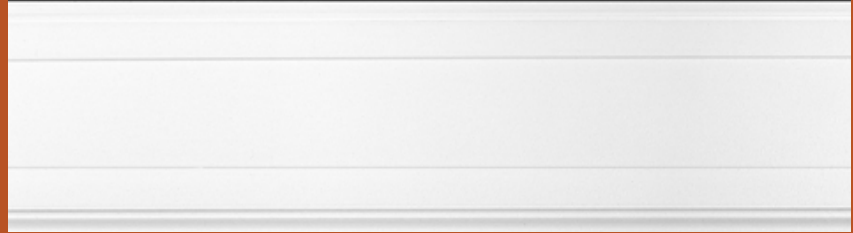

PX102

Mini Mouldings

8 Ft. Lengths

Measurements are approximate

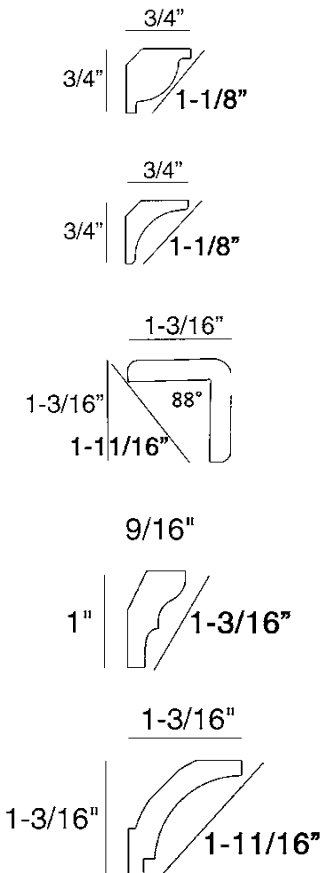

CX132

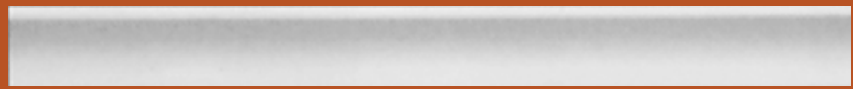

CX133



CX134

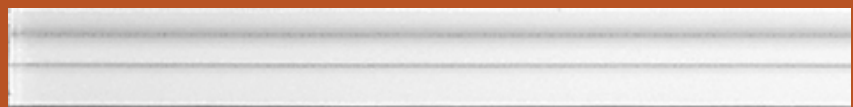

CX111

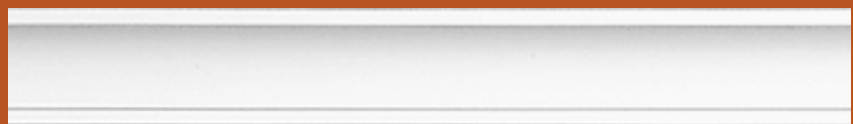

CX115

