

FYPON

WINDOW AND DOOR TRIM



PRODUCT CATALOG 



Crosshead



Pediment



Arch Trim



Pilaster



Keystone

MAKE A GRAND ENTRANCE.

Nothing can make a statement and enhance architectural style like Window and Door Trim. Offering a wide range of styles and sizes to complement almost any type of home, Window and Door Trim can transform an ordinary home into an extraordinary home. Many pieces are designed to work together and some can be ordered moulded as one piece to further speed installation. From Pilasters, Pediments and Crossheads to Arches and Panels, the options are virtually countless – giving you the freedom to design a specialized look for your next project. **For installation instructions, refer to the back of the comprehensive, full-line product catalog or visit www.fypon.com.**



BASIC WINDOW TRIM TERMINOLOGY

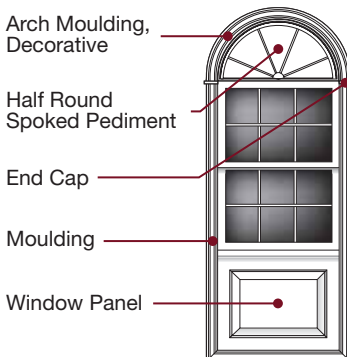

BASIC DOOR TRIM TERMINOLOGY

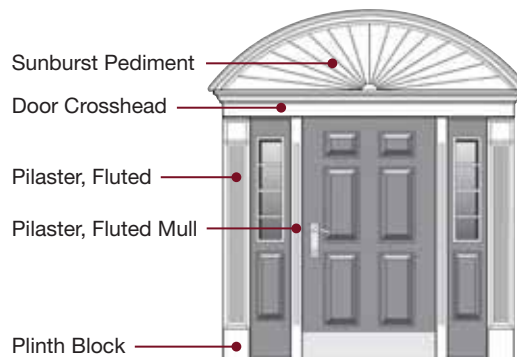

FYPON

HOW TO ORDER WINDOW TRIM.

When ordering Window Trim, first measure the window unit to be trimmed. Next choose the desired products.

WINDOW TRIM ACCESSORIES

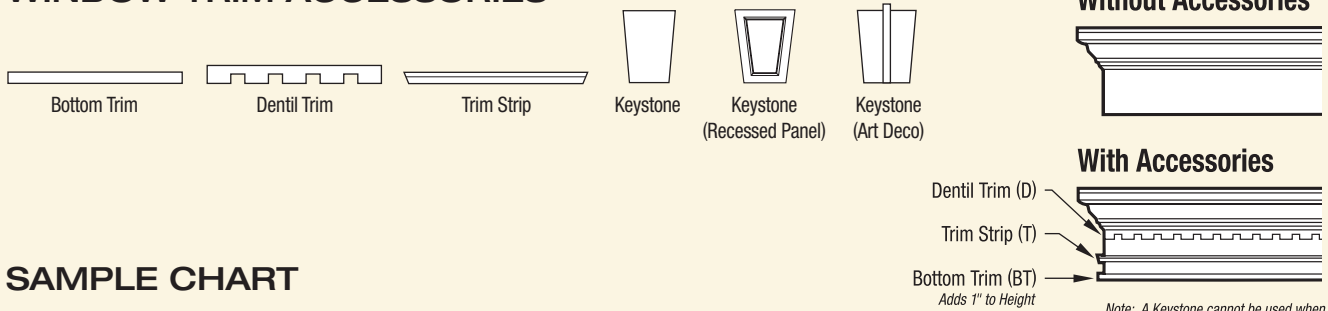

SAMPLE CHART

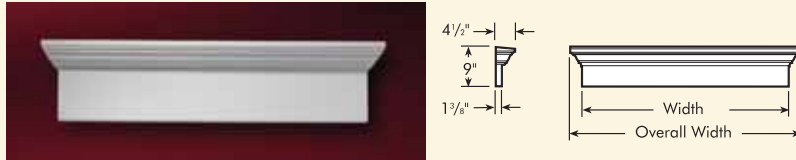

9" Window Crosshead

UNATTACHED ACCESSORIES

DIMENSIONS				Keystone (Page 49 WD)
Part Number	Width	Overall Width	Height	
WCH24X9	24"	29 1/2"	9"	K9M
WCH24X10BT	24"	29 1/2"	10"	
WCH25X9	25 5/8"	31 1/8"	9"	K9M
WCH25X10BT	25 5/8"	31 1/8"	10"	

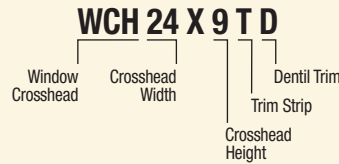
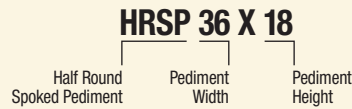

All items are coded alphanumerically – starting with letters as a product abbreviation, numbers showing the size and any additional letters on the end describing the options above.

ORDERING COMBINATION PEDIMENTS AND/OR WINDOW CROSSHEADS WITH ATTACHED ACCESSORIES.

Dentil Trim, Trim Strip and Bottom Trim are available pre-attached. These are indicated in the catalog where applicable.

To order with attached Bottom Trim, refer to the part number in color listed with regular part number.

Bottom Trim adds 1" to height and/or overall height.
WCH54X10BT

To order attached Dentil Trim or Trim Strip, add the corresponding letter to the end of the part number.

WCH54X9D

Add "D" after the part number.

WCH54X9T

Add "T" after the part number.

WCH54X9K

Add "K", "KP" or "KA" after the part number, depending on which style of Keystone you desire.

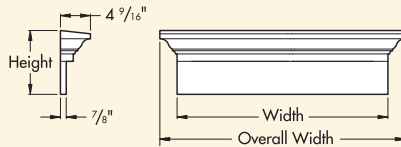

8" and 10" Traditional Window Crosshead

UNATTACHED ACCESSORIES

ATTACHED ACCESSORIES

DIMENSIONS



Part Number	Width	Height	Overall Width	Projection	Keystone (Page 50 WD)
CCA34X8	34"	8"	39 7/32"	4 9/16"	KCCA8
CCA34X9BT	34"	9"	39 7/32"	4 9/16"	
CCA102X8	102"	8"	107 7/32"	4 9/16"	KCCA8
CCA102X9BT	102"	9"	107 7/32"	4 9/16"	
CCA32X10	32"	9 1/16"	37 7/32"	4 9/16"	KCCA10
CCA32X11BT	32"	10 1/16"	37 7/32"	4 9/16"	
CCA34X10	34"	9 1/16"	39 7/32"	4 9/16"	KCCA10
CCA34X11BT	34"	10 1/16"	39 7/32"	4 9/16"	
CCA36X10	36"	9 1/16"	41 7/32"	4 9/16"	KCCA10
CCA36X11BT	36"	10 1/16"	41 7/32"	4 9/16"	
CCA52X10	52"	9 1/16"	57 7/32"	4 9/16"	KCCA10
CCA52X11BT	52"	10 1/16"	57 7/32"	4 9/16"	
CCA64X10	64"	9 1/16"	69 7/32"	4 9/16"	KCCA10
CCA64X11BT	64"	10 1/16"	69 7/32"	4 9/16"	
CCA68X10	68"	9 1/16"	73 7/32"	4 9/16"	KCCA10
CCA68X11BT	68"	10 1/16"	73 7/32"	4 9/16"	
CCA72X10	72"	9 1/16"	77 7/32"	4 9/16"	KCCA10
CCA72X11BT	72"	10 1/16"	77 7/32"	4 9/16"	
CCA100X10	100"	9 1/16"	105 7/32"	4 9/16"	KCCA10
CCA100X11BT	100"	10 1/16"	105 7/32"	4 9/16"	
CCA102X10	102"	9 1/16"	107 7/32"	4 9/16"	KCCA10
CCA102X11BT	102"	10 1/16"	107 7/32"	4 9/16"	
CCA105X10	105"	9 1/16"	110 7/32"	4 9/16"	KCCA10
CCA105X11BT	105"	10 1/16"	110 7/32"	4 9/16"	
CCA106X10	106"	9 1/16"	111 7/32"	4 9/16"	KCCA10
CCA106X11BT	106"	10 1/16"	111 7/32"	4 9/16"	

The following accessories are available pre-attached to this product. To order, simply add the corresponding letter (found below the accessory drawing in parenthesis) to the main product number. To order more than one attached accessory, list all the corresponding letters of the accessories you select to the main product number. All items with attached accessories are shipped from our facility within five working days and are non-returnable.

EXAMPLE: **CCA32X10 T K**

Part Number Trim Strip Keystone



Trim Strip (T)
(MLD602)



Dentil Trim (D)
(MLD304)



Keystone (K)

Note: A Keystone cannot be used when combining a Crosshead with a Pediment.

Part numbers in red indicate products with Bottom Trim, which add an inch to the height of the product.

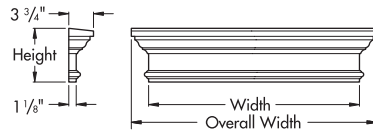

8" and 10" Traditional Window Crosshead with Trim Strip

UNATTACHED ACCESSORIES

ATTACHED ACCESSORIES

DIMENSIONS

Part Number	Width	Height	Overall Width	Projection	Keystone (Page 51 WD)
CCB20X8	20"	8 5/32"	25 1/4"	3 3/4"	KCCB8
CCB20X9BT	20"	9 5/32"	25 1/4"	3 3/4"	
CCB32X8	32"	8 5/32"	37 1/4"	3 3/4"	KCCB8
CCB32X9BT	32"	9 5/32"	37 1/4"	3 3/4"	
CCB36X8	36"	8 5/32"	41 1/4"	3 3/4"	KCCB8
CCB36X9BT	36"	9 5/32"	41 1/4"	3 3/4"	
CCB40X8	40"	8 5/32"	45 1/4"	3 3/4"	KCCB8
CCB40X9BT	40"	9 5/32"	45 1/4"	3 3/4"	
CCB64X8	64"	8 5/32"	69 1/4"	3 3/4"	KCCB8
CCB64X9BT	64"	9 5/32"	69 1/4"	3 3/4"	
CCB66X8	66"	8 5/32"	71 1/4"	3 3/4"	KCCB8
CCB66X9BT	66"	9 5/32"	71 1/4"	3 3/4"	
CCB68X8	68"	8 5/32"	73 1/4"	3 3/4"	KCCB8
CCB68X9BT	68"	9 5/32"	73 1/4"	3 3/4"	
CCB76X8	76"	8 5/32"	81 1/4"	3 3/4"	KCCB8
CCB76X9BT	76"	9 5/32"	81 1/4"	3 3/4"	
CCB78X8	78"	8 5/32"	83 1/4"	3 3/4"	KCCB8
CCB78X9BT	78"	9 5/32"	83 1/4"	3 3/4"	
CCB101X8	101"	8 5/32"	106 1/4"	3 3/4"	KCCB8
CCB101X9BT	101"	9 5/32"	106 1/4"	3 3/4"	
CCB102X8	102"	8 5/32"	107 1/4"	3 3/4"	KCCB8
CCB102X9BT	102"	9 5/32"	107 1/4"	3 3/4"	
CCB106X8	106"	8 5/32"	111 1/4"	3 3/4"	KCCB8
CCB106X9BT	106"	9 5/32"	111 1/4"	3 3/4"	
CCB198X8	198"	8 5/32"	203 1/4"	3 3/4"	KCCB8
CCB198X9BT	198"	9 5/32"	203 1/4"	3 3/4"	
CCB102X10	102"	10"	107 1/4"	3 3/4"	—
CCB102X11BT	102"	11"	107 1/4"	3 3/4"	—



The following accessories are available pre-attached to this product. To order, simply add the corresponding letter (found below the accessory drawing in parenthesis) to the main product number. To order more than one attached accessory, list all the corresponding letters of the accessories you select to the main product number. All items with attached accessories are shipped from our facility within five working days and are non-returnable.

EXAMPLE: CCB20X8 D K

Part Number Dentil Trim Keystone

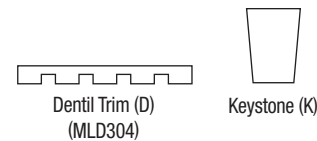

Note: A Keystone cannot be used when combining a Crosshead with a Pediment.

Part numbers in red indicate products with Bottom Trim, which add an inch to the height of the product.

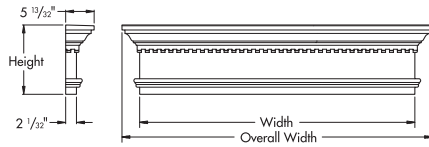

13" Traditional Window Crosshead with Dentil Trim

DIMENSIONS

Part Number	Width	Height	Overall Width	Projection
CCC82X13	82"	13 ⁵ / ₃₂ "	88 ²³ / ₃₂ "	5 ¹³ / ₃₂ "
CCC82X14BT	82"	14 ⁵ / ₃₂ "	88 ²³ / ₃₂ "	5 ¹³ / ₃₂ "

Part numbers in red indicate products with Bottom Trim, which add an inch to the height of the product.

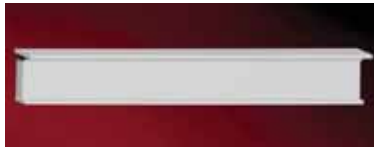

8" CHA Crosshead with Bottom Trim

DIMENSIONS

Part Number	Width	Height	Overall Width	Projection
CHA26X8BT	26"	8"	29"	2 1/2"
CHA28X8BT	28"	8"	31"	2 1/2"
CHA30X8BT	30"	8"	33"	2 1/2"
CHA32X8BT	32"	8"	35"	2 1/2"
CHA48X8BT	48"	8"	51"	2 1/2"
CHA52X8BT	52"	8"	55"	2 1/2"
CHA204X8BT	204"	8"	207"	2 1/2"

Part numbers in red indicate products with Bottom Trim, which add an inch to the height of the product.

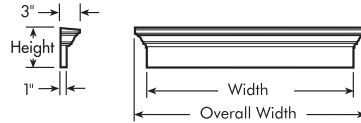

TIP: Window Crossheads can also be used in a Door Crosshead application.

6" Window Crosshead

UNATTACHED ACCESSORIES

ATTACHED ACCESSORIES

DIMENSIONS

Part Number	Width	Overall Width	Height	UNATTACHED ACCESSORIES	
				Keystone <i>(Page 49 WD)</i>	Keystone (Recessed Panel) <i>(Page 76 WD)</i>
WCH24X6	24"	27 1/2"	6"		
WCH24X7BT	24"	27 1/2"	7"	K6M	KP6M
WCH28X6	28"	31 1/2"	6"		
WCH28X7BT	28"	31 1/2"	7"	K6M	KP6M
WCH30X6	30"	33 1/2"	6"		
WCH30X7BT	30"	33 1/2"	7"	K6M	KP6M
WCH31X6	31"	34 1/2"	6"		
WCH31X7BT	31"	34 1/2"	7"	K6M	KP6M
WCH32X6	32"	35 1/2"	6"		
WCH32X7BT	32"	35 1/2"	7"	K6M	KP6M
WCH33X6	33 5/8"	37 1/8"	6"		
WCH33X7BT	33 5/8"	37 1/8"	7"	K6M	KP6M
WCH34X6	34"	37 1/2"	6"		
WCH34X7BT	34"	37 1/2"	7"	K6M	KP6M
WCH35X6	35"	38 1/2"	6"		
WCH35X7BT	35"	38 1/2"	7"	K6M	KP6M
WCH36X6	36"	39 1/2"	6"		
WCH36X7BT	36"	39 1/2"	7"	K6M	KP6M
WCH37X6	37 5/8"	41 1/8"	6"		
WCH37X7BT	37 5/8"	41 1/8"	7"	K6M	KP6M
WCH38X6	38"	41 1/2"	6"		
WCH38X7BT	38"	41 1/2"	7"	K6M	KP6M
WCH40X6	40"	43 1/2"	6"		
WCH40X7BT	40"	43 1/2"	7"	K6M	KP6M
WCH41X6	41 5/8"	45 1/8"	6"		
WCH41X7BT	41 5/8"	45 1/8"	7"	K6M	KP6M
WCH43X6	43"	46 1/2"	6"		
WCH43X7BT	43"	46 1/2"	7"	K6M	KP6M
WCH44X6	44"	47 1/2"	6"		
WCH44X7BT	44"	47 1/2"	7"	K6M	KP6M

The following accessories are available pre-attached to this product. To order, simply add the corresponding letter (found below the accessory drawing in parenthesis) to the main product number. To order more than one attached accessory, list all the corresponding letters of the accessories you select to the main product number. All items with attached accessories are shipped from our facility within five working days and are non-returnable.

EXAMPLE: WCH24X6 T KP

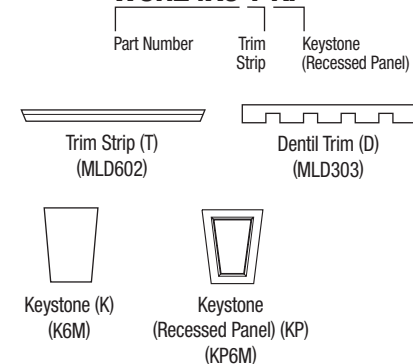

Note: A Keystone cannot be used when combining a Crosshead with a Pediment.

Part numbers in red indicate products with Bottom Trim, which add an inch to the height of the product.

CHART CONTINUED ON FOLLOWING PAGE.

6" Window Crosshead (continued)



UNATTACHED ACCESSORIES

ATTACHED ACCESSORIES

DIMENSIONS



Part Number	Width	Overall Width	Height	Keystone (Page 49 WD)	Keystone (Recessed Panel) (Page 76 WD)
WCH46X6	46"	49 1/2"	6"	K6M	KP6M
WCH46X7BT	46"	49 1/2"	7"		
WCH48X6	48"	51 1/2"	6"	K6M	KP6M
WCH48X7BT	48"	51 1/2"	7"		
WCH51X6	51"	54 1/2"	6"	K6M	KP6M
WCH51X7BT	51"	54 1/2"	7"		
WCH56X6	56"	59 1/2"	6"	K6M	KP6M
WCH56X7BT	56"	59 1/2"	7"		
WCH60X6	60"	63 1/2"	6"	K6M	KP6M
WCH60X7BT	60"	63 1/2"	7"		
WCH64X6	64"	67 1/2"	6"	K6M	KP6M
WCH64X7BT	64"	67 1/2"	7"		
WCH66X6	66"	69 1/2"	6"	K6M	KP6M
WCH66X7BT	66"	69 1/2"	7"		
WCH68X6	68"	71 1/2"	6"	K6M	KP6M
WCH68X7BT	68"	71 1/2"	7"		
WCH72X6	72"	75 1/2"	6"	K6M	KP6M
WCH72X7BT	72"	75 1/2"	7"		
WCH73X6	73"	76 1/2"	6"	K6M	KP6M
WCH73X7BT	73"	76 1/2"	7"		
WCH74X6	74"	77 1/2"	6"	K6M	KP6M
WCH74X7BT	74"	77 1/2"	7"		
WCH76X6	76"	79 1/2"	6"	K6M	KP6M
WCH76X7BT	76"	79 1/2"	7"		
WCH78X6	78"	81 1/2"	6"	K6M	KP6M
WCH78X7BT	78"	81 1/2"	7"		
WCH80X6	80"	83 1/2"	6"	K6M	KP6M
WCH80X7BT	80"	83 1/2"	7"		
WCH80.5X6	80 1/2"	84"	6"	K6M	KP6M
WCH80.5X7BT	80 1/2"	84"	7"		
WCH87X6	87"	90 1/2"	6"	K6M	KP6M
WCH87X7BT	87"	90 1/2"	7"		
WCH96X6	96"	99 1/2"	6"	K6M	KP6M
WCH96X7BT	96"	99 1/2"	7"		

The following accessories are available pre-attached to this product. To order, simply add the corresponding letter (found below the accessory drawing in parenthesis) to the main product number. To order more than one attached accessory, list all the corresponding letters of the accessories you select to the main product number. All items with attached accessories are shipped from our facility within five working days and are non-returnable.

EXAMPLE: WCH24X6 T KP

Part Number
Trim Strip
Keystone (Recessed Panel)

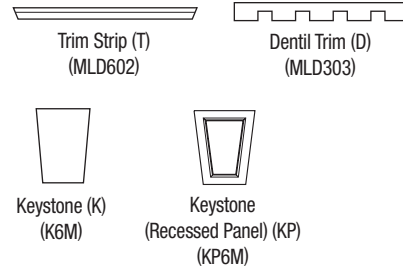

Note: A Keystone cannot be used when combining a Crosshead with a Pediment.

Part numbers in red indicate products with Bottom Trim, which add an inch to the height of the product.

CHART CONTINUED ON FOLLOWING PAGE.

6" Window Crosshead (continued)



UNATTACHED ACCESSORIES

ATTACHED ACCESSORIES

DIMENSIONS

Part Number	Width	Overall Width	Height	UNATTACHED ACCESSORIES	
				Keystone (Page 49 WD)	Keystone (Recessed Panel) (Page 76 WD)
WCH100X6	100"	103 1/2"	6"	K6M	KP6M
WCH100X7BT	100"	103 1/2"	7"		
WCH104X6	104"	107 1/2"	6"	K6M	KP6M
WCH104X7BT	104"	107 1/2"	7"		
WCH108X6	108"	111 1/2"	6"	K6M	KP6M
WCH108X7BT	108"	111 1/2"	7"		
WCH110X6	110"	113 1/2"	6"	K6M	KP6M
WCH110X7BT	110"	113 1/2"	7"		
WCH144X6	144"	147 1/2"	6"	K6M	KP6M
WCH144X7BT	144"	147 1/2"	7"		

Part numbers in red indicate products with Bottom Trim, which add an inch to the height of the product.

The following accessories are available pre-attached to this product. To order, simply add the corresponding letter (found below the accessory drawing in parenthesis) to the main product number. To order more than one attached accessory, list all the corresponding letters of the accessories you select to the main product number. All items with attached accessories are shipped from our facility within five working days and are non-returnable.

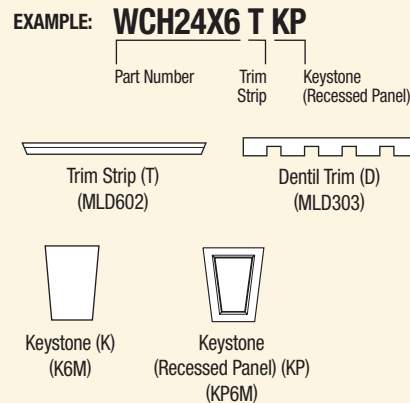

Note: A Keystone cannot be used when combining a Crosshead with a Pediment.

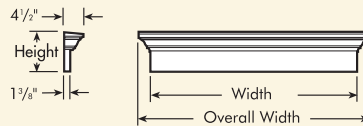

TIP: Window Crossheads can also be used in a Door Crosshead application.

9" Window Crosshead

UNATTACHED ACCESSORIES

ATTACHED ACCESSORIES

DIMENSIONS

Part Number	Width	Overall Width	Height	UNATTACHED ACCESSORIES		
				Keystone (Page 49 WD)	Keystone (Recessed Panel) (Page 49 WD)	Keystone (Art Deco) (Page 49 WD)
WCH20X9	20"	25 1/2"	9"	K9M	KP9M	KA9M
WCH20X10BT	20"	25 1/2"	10"			
WCH24X9	24"	29 1/2"	9"	K9M	KP9M	KA9M
WCH24X10BT	24"	29 1/2"	10"			
WCH25X9	25 5/8"	31 1/8"	9"	K9M	KP9M	KA9M
WCH25X10BT	25 5/8"	31 1/8"	10"			
WCH27X9	27"	32 1/2"	9"	K9M	KP9M	KA9M
WCH27X10BT	27"	32 1/2"	10"			
WCH28X9	28"	33 1/2"	9"	K9M	KP9M	KA9M
WCH28X10BT	28"	33 1/2"	10"			

Part numbers in red indicate products with Bottom Trim, which add an inch to the height of the product.

The following accessories are available pre-attached to this product. To order, simply add the corresponding letter (found below the accessory drawing in parenthesis) to the main product number. To order more than one attached accessory, list all the corresponding letters of the accessories you select to the main product number. All items with attached accessories are shipped from our facility within five working days and are non-returnable.

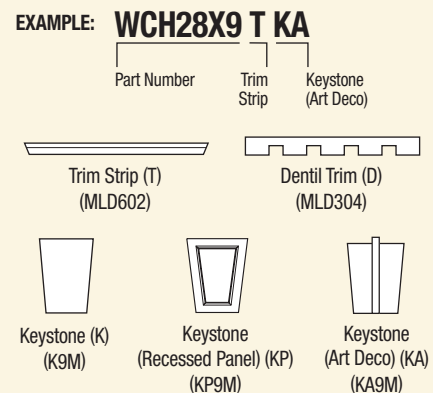

Note: A Keystone cannot be used when combining a Crosshead with a Pediment.

CHART CONTINUED ON FOLLOWING PAGE.

9" Window Crosshead (continued)

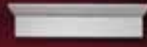

UNATTACHED ACCESSORIES

ATTACHED ACCESSORIES

DIMENSIONS



Part Number	Width	Overall Width	Height	Keystone (Page 49 WD)	Keystone (Recessed Panel) (Page 49 WD)	Keystone (Art Deco) (Page 49 WD)
WCH29X9	29 5/8"	35 1/8"	9"	K9M	KP9M	KA9M
WCH29X10BT	29 5/8"	35 1/8"	10"			
WCH30X9	30 1/4"	35 3/4"	9"	K9M	KP9M	KA9M
WCH30X10BT	30 1/4"	35 3/4"	10"			
WCH31X9	31"	36 1/2"	9"	K9M	KP9M	KA9M
WCH31X10BT	31"	36 1/2"	10"			
WCH32X9	32"	37 1/2"	9"	K9M	KP9M	KA9M
WCH32X10BT	32"	37 1/2"	10"			
WCH33X9	33 5/8"	39 1/8"	9"	K9M	KP9M	KA9M
WCH33X10BT	33 5/8"	39 1/8"	10"			
WCH34X9	34"	39 1/2"	9"	K9M	KP9M	KA9M
WCH34X10BT	34"	39 1/2"	10"			
WCH36X9	36"	41 1/2"	9"	K9M	KP9M	KA9M
WCH36X10BT	36"	41 1/2"	10"			
WCH37X9	37 5/8"	43 1/8"	9"	K9M	KP9M	KA9M
WCH37X10BT	37 5/8"	43 1/8"	10"			
WCH38X9	38"	43 1/2"	9"	K9M	KP9M	KA9M
WCH38X10BT	38"	43 1/2"	10"			
WCH40X9	40"	45 1/2"	9"	K9M	KP9M	KA9M
WCH40X10BT	40"	45 1/2"	10"			
WCH41X9	41 5/8"	47 1/8"	9"	K9M	KP9M	KA9M
WCH41X10BT	41 5/8"	47 1/8"	10"			
WCH43X9	43"	48 1/2"	9"	K9M	KP9M	KA9M
WCH43X10BT	43"	48 1/2"	10"			
WCH44X9	44"	49 1/2"	9"	K9M	KP9M	KA9M
WCH44X10BT	44"	49 1/2"	10"			
WCH48X9	48"	53 1/2"	9"	K9M	KP9M	KA9M
WCH48X10BT	48"	53 1/2"	10"			
WCH49X9	49"	54 1/2"	9"	K9M	KP9M	KA9M
WCH49X10BT	49"	54 1/2"	10"			
WCH58X9	58"	63 1/2"	9"	K9M	KP9M	KA9M
WCH58X10BT	58"	63 1/2"	10"			
WCH60X9	60"	65 1/2"	9"	K9M	KP9M	KA9M
WCH60X10BT	60"	65 1/2"	10"			

The following accessories are available pre-attached to this product. To order, simply add the corresponding letter (found below the accessory drawing in parenthesis) to the main product number. To order more than one attached accessory, list all the corresponding letters of the accessories you select to the main product number. All items with attached accessories are shipped from our facility within five working days and are non-returnable.

EXAMPLE: **WCH28X9 T KA**

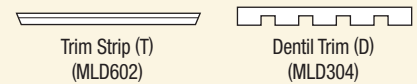

Note: A Keystone cannot be used when combining a Crosshead with a Pediment.

Part numbers in red indicate products with Bottom Trim, which add an inch to the height of the product.

CHART CONTINUED ON FOLLOWING PAGE.

9" Window Crosshead (continued)

UNATTACHED ACCESSORIES

ATTACHED ACCESSORIES

Part Number	DIMENSIONS			UNATTACHED ACCESSORIES		
	Width	Overall Width	Height	Keystone (Page 49 WD)	Keystone (Recessed Panel) (Page 49 WD)	Keystone (Art Deco) (Page 49 WD)
WCH64X9	64"	69 1/2"	9"	K9M	KP9M	KA9M
WCH64X10BT	64"	69 1/2"	10"			
WCH65X9	65"	70 1/2"	9"	K9M	KP9M	KA9M
WCH65X10BT	65"	70 1/2"	10"			
WCH66X9	66"	71 1/2"	9"	K9M	KP9M	KA9M
WCH66X10BT	66"	71 1/2"	10"			
WCH68X9	68"	73 1/2"	9"	K9M	KP9M	KA9M
WCH68X10BT	68"	73 1/2"	10"			
WCH72X9	72"	77 1/2"	9"	K9M	KP9M	KA9M
WCH72X10BT	72"	77 1/2"	10"			
WCH73X9	73"	78 1/2"	9"	K9M	KP9M	KA9M
WCH73X10BT	73"	78 1/2"	10"			
WCH74X9	74"	79 1/2"	9"	K9M	KP9M	KA9M
WCH74X10BT	74"	79 1/2"	10"			
WCH75X9	75"	80 1/2"	9"	K9M	KP9M	KA9M
WCH75X10BT	75"	80 1/2"	10"			
WCH76X9	76"	81 1/2"	9"	K9M	KP9M	KA9M
WCH76X10BT	76"	81 1/2"	10"			
WCH77X9	77"	82 1/2"	9"	K9M	KP9M	KA9M
WCH77X10BT	77"	82 1/2"	10"			
WCH78X9	78"	83 1/2"	9"	K9M	KP9M	KA9M
WCH78X10BT	78"	83 1/2"	10"			
WCH80X9	80"	85 1/2"	9"	K9M	KP9M	KA9M
WCH80X10BT	80"	85 1/2"	10"			
WCH82X9	82"	87 1/2"	9"	K9M	KP9M	KA9M
WCH82X10BT	82"	87 1/2"	10"			
WCH84X9	84"	89 1/2"	9"	K9M	KP9M	KA9M
WCH84X10BT	84"	89 1/2"	10"			
WCH85X9	85"	90 1/2"	9"	K9M	KP9M	KA9M
WCH85X10BT	85"	90 1/2"	10"			
WCH96X9	96"	101 1/2"	9"	K9M	KP9M	KA9M
WCH96X10BT	96"	101 1/2"	10"			
WCH99X9	99"	104 1/2"	9"	K9M	KP9M	KA9M
WCH99X10BT	99"	104 1/2"	10"			

The following accessories are available pre-attached to this product. To order, simply add the corresponding letter (found below the accessory drawing in parenthesis) to the main product number. To order more than one attached accessory, list all the corresponding letters of the accessories you select to the main product number. All items with attached accessories are shipped from our facility within five working days and are non-returnable.

EXAMPLE: **WCH28X9 T KA**

Part Number Trim Strip Keystone (Art Deco)

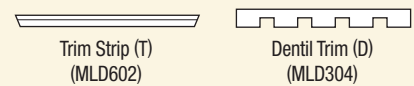

Note: A Keystone cannot be used when combining a Crosshead with a Pediment.

Part numbers in red indicate products with Bottom Trim, which add an inch to the height of the product.

CHART CONTINUED ON FOLLOWING PAGE.

9" Window Crosshead (continued)



UNATTACHED ACCESSORIES

ATTACHED ACCESSORIES

DIMENSIONS



Part Number	Width	Overall Width	Height	Keystone (Page 49 WD)	Keystone (Recessed Panel) (Page 49 WD)	Keystone (Art Deco) (Page 49 WD)
WCH100X9	100"	105 1/2"	9"	K9M	KP9M	KA9M
WCH100X10BT	100"	105 1/2"	10"			
WCH101X9	101"	106 1/2"	9"	K9M	KP9M	KA9M
WCH101X10BT	101"	106 1/2"	10"			
WCH103X9	103"	108 1/2"	9"	K9M	KP9M	KA9M
WCH103X10BT	103"	108 1/2"	10"			
WCH104X9	104"	109 1/2"	9"	K9M	KP9M	KA9M
WCH104X10BT	104"	109 1/2"	10"			
WCH108X9	108"	113 1/2"	9"	K9M	KP9M	KA9M
WCH108X10BT	108"	113 1/2"	10"			
WCH110X9	110"	115 1/2"	9"	K9M	KP9M	KA9M
WCH110X10BT	110"	115 1/2"	10"			
WCH113X9	113"	118 1/2"	9"	K9M	KP9M	KA9M
WCH113X10BT	113"	118 1/2"	10"			
WCH124X9	124"	129 1/2"	9"	K9M	KP9M	KA9M
WCH124X10BT	124"	129 1/2"	10"			
WCH144X9	144"	149 1/2"	9"	K9M	KP9M	KA9M
WCH144X10BT	144"	149 1/2"	10"			
WCH192X9	192"	197 1/2"	9"	K9M	KP9M	KA9M
WCH192X10BT	192"	197 1/2"	10"			
WCH197X9	197"	202 1/2"	9"	K9M	KP9M	KA9M
WCH197X10BT	197"	202 1/2"	10"			
WCH200X9	200"	205 1/2"	9"	K9M	KP9M	KA9M
WCH200X10BT	200"	205 1/2"	10"			
WCH204X9	204"	209 1/2"	9"	K9M	KP9M	KA9M
WCH204X10BT	204"	209 1/2"	10"			
WCH207X9	207"	212 1/2"	9"	K9M	KP9M	KA9M
WCH207X10BT	207"	212 1/2"	10"			

The following accessories are available pre-attached to this product. To order, simply add the corresponding letter (found below the accessory drawing in parenthesis) to the main product number. To order more than one attached accessory, list all the corresponding letters of the accessories you select to the main product number. All items with attached accessories are shipped from our facility within five working days and are non-returnable.

EXAMPLE: **WCH28X9 T KA**

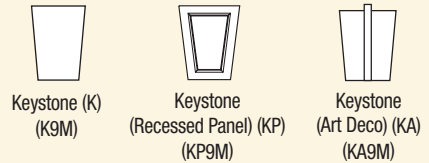
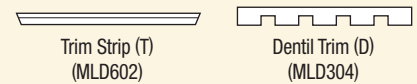

Note: A Keystone cannot be used when combining a Crosshead with a Pediment.

Part numbers in red indicate products with Bottom Trim, which add an inch to the height of the product.

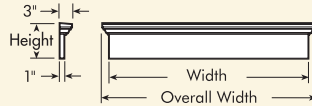

TIP: Window Crossheads can also be used in a Door Crosshead application.

9" Window Crosshead, Narrow Projection

UNATTACHED ACCESSORIES

ATTACHED ACCESSORIES

DIMENSIONS

Part Number	Width	Overall Width	Height	Keystone (Page 49 WD)
WCH30X9N	30"	33 1/2"	9"	K9MN
WCH30X10NBT	30"	33 1/2"	10"	
WCH32X9N	32"	35 1/2"	9"	K9MN
WCH32X10NBT	32"	35 1/2"	10"	
WCH33X9N	33 5/8"	37 1/8"	9"	K9MN
WCH33X10NBT	33 5/8"	37 1/8"	10"	
WCH36X9N	36"	39 1/2"	9"	K9MN
WCH36X10NBT	36"	39 1/2"	10"	
WCH37X9N	37 5/8"	41 1/8"	9"	K9MN
WCH37X10NBT	37 5/8"	41 1/8"	10"	
WCH40X9N	40"	43 1/2"	9"	K9MN
WCH40X10NBT	40"	43 1/2"	10"	
WCH41X9N	41 5/8"	45 1/8"	9"	K9MN
WCH41X10NBT	41 5/8"	45 1/8"	10"	
WCH44X9N	44"	47 1/2"	9"	K9MN
WCH44X10NBT	44"	47 1/2"	10"	
WCH48X9N	48"	51 1/2"	9"	K9MN
WCH48X10NBT	48"	51 1/2"	10"	
WCH50X9N	50"	53 1/2"	9"	K9MN
WCH50X10NBT	50"	53 1/2"	10"	
WCH54X9N	54"	57 1/2"	9"	K9MN
WCH54X10NBT	54"	57 1/2"	10"	
WCH60X9N	60"	63 1/2"	9"	K9MN
WCH60X10NBT	60"	63 1/2"	10"	

The following accessories are available pre-attached to this product. To order, simply add the corresponding letter (found below the accessory drawing in parenthesis) to the main product number. To order more than one attached accessory, list all the corresponding letters of the accessories you select to the main product number. All items with attached accessories are shipped from our facility within five working days and are non-returnable.

EXAMPLE: WCH30X9N T K

Part Number Trim Strip Keystone



Trim Strip (T)
(MLD602)

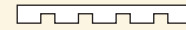

Dentil Trim (D)
(MLD304)



Keystone (K)
(K9MN)

Note: A Keystone cannot be used when combining a Crosshead with a Pediment.

Part numbers in red indicate products with Bottom Trim, which add an inch to the height of the product.

CHART CONTINUED ON FOLLOWING PAGE.

9" Window Crosshead, Narrow Projection (continued)



UNATTACHED ACCESSORIES

ATTACHED ACCESSORIES

DIMENSIONS



Part Number	Width	Overall Width	Height	Keystone (Page 49 WD)
WCH72X9N	72"	75 1/2"	9"	K9MN
WCH72X10NBT	72"	75 1/2"	10"	
WCH76X9N	76"	79 1/2"	9"	K9MN
WCH76X10NBT	76"	79 1/2"	10"	
WCH81X9N	81"	84 1/2"	9"	K9MN
WCH81X10NBT	81"	84 1/2"	10"	
WCH84X9N	84"	87 1/2"	9"	K9MN
WCH84X10NBT	84"	87 1/2"	10"	
WCH85X9N	85"	88 1/2"	9"	K9MN
WCH85X10NBT	85"	88 1/2"	10"	
WCH86X9N	86"	89 1/2"	9"	K9MN
WCH86X10NBT	86"	89 1/2"	10"	
WCH144X9N	144"	147 1/2"	9"	K9MN
WCH144X10NBT	144"	147 1/2"	10"	
WCH204X9N	204"	207 1/2"	9"	K9MN
WCH204X10NBT	204"	207 1/2"	10"	

The following accessories are available pre-attached to this product. To order, simply add the corresponding letter (found below the accessory drawing in parenthesis) to the main product number. To order more than one attached accessory, list all the corresponding letters of the accessories you select to the main product number. All items with attached accessories are shipped from our facility within five working days and are non-returnable.

EXAMPLE: WCH30X9N T K

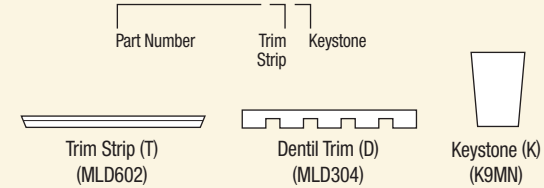

Note: A Keystone cannot be used when combining a Crosshead with a Pediment.

Part numbers in red indicate products with Bottom Trim, which add an inch to the height of the product.

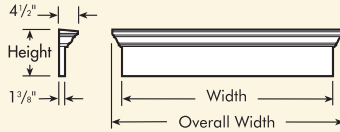

TIP: Window Crossheads can also be used in a Door Crosshead application.

12" Window Crosshead

UNATTACHED ACCESSORIES

ATTACHED ACCESSORIES

DIMENSIONS

Part Number	Width	Overall Width	Height	Keystone (Page 50 WD)
WCH32X12	32"	37 1/2"	12"	K12M
WCH32X13BT	32"	37 1/2"	13"	
WCH33X12	33 5/8"	39 1/8"	12"	K12M
WCH33X13BT	33 5/8"	39 1/8"	13"	
WCH36X12	36"	41 1/2"	12"	K12M
WCH36X13BT	36"	41 1/2"	13"	
WCH37X12	37 5/8"	43 1/8"	12"	K12M
WCH37X13BT	37 5/8"	43 1/8"	13"	
WCH40X12	40"	45 1/2"	12"	K12M
WCH40X13BT	40"	45 1/2"	13"	
WCH41X12	41 5/8"	47 1/8"	12"	K12M
WCH41X13BT	41 5/8"	47 1/8"	13"	
WCH44X12	44"	49 1/2"	12"	K12M
WCH44X13BT	44"	49 1/2"	13"	
WCH48X12	48"	53 1/2"	12"	K12M
WCH48X13BT	48"	53 1/2"	13"	
WCH56X12	56"	61 1/2"	12"	K12M
WCH56X13BT	56"	61 1/2"	13"	
WCH64X12	64"	69 1/2"	12"	K12M
WCH64X13BT	64"	69 1/2"	13"	
WCH72X12	72"	77 1/2"	12"	K12M
WCH72X13BT	72"	77 1/2"	13"	
WCH76X12	76"	81 1/2"	12"	K12M
WCH76X13BT	76"	81 1/2"	13"	
WCH96X12	96"	101 1/2"	12"	K12M
WCH96X13BT	96"	101 1/2"	13"	
WCH102X12	102"	107 1/2"	12"	K12M
WCH102X13BT	102"	107 1/2"	13"	
WCH144X12	144"	149 1/2"	12"	K12M
WCH144X13BT	144"	149 1/2"	13"	

Part numbers in red indicate products with Bottom Trim, which add an inch to the height of the product.

The following accessories are available pre-attached to this product. To order, simply add the corresponding letter (found below the accessory drawing in parenthesis) to the main product number. To order more than one attached accessory, list all the corresponding letters of the accessories you select to the main product number. All items with attached accessories are shipped from our facility within five working days and are non-returnable.

EXAMPLE: WCH32X12 T K

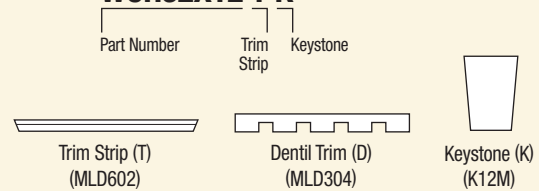

Note: A Keystone cannot be used when combining a Crosshead with a Pediment.

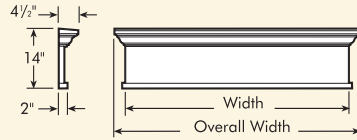

TIP: Window Crossheads can also be used in a Door Crosshead application.

14" Window Crosshead with Bottom Trim

UNATTACHED ACCESSORIES

ATTACHED ACCESSORIES

DIMENSIONS



Part Number	Width	Overall Width	Keystone (Page 50 WD)
WCH33X14BT	33 5/8"	39 1/8"	K14M
WCH36X14BT	36"	41 1/2"	K14M
WCH37X14BT	37 5/8"	43 1/8"	K14M
WCH40X14BT	40"	45 1/2"	K14M
WCH41X14BT	41 5/8"	47 1/8"	K14M
WCH44X14BT	44"	49 1/2"	K14M
WCH48X14BT	48"	53 1/2"	K14M
WCH72X14BT	72"	77 1/2"	K14M
WCH76X14BT	76"	81 1/2"	K14M
WCH96X14BT	96"	101 1/2"	K14M
WCH144X14BT	144"	149 1/2"	K14M

The following accessories are available pre-attached to this product. To order, simply add the corresponding letter (found below the accessory drawing in parenthesis) to the main product number. To order more than one attached accessory, list all the corresponding letters of the accessories you select to the main product number. All items with attached accessories are shipped from our facility within five working days and are non-returnable.

EXAMPLE: WCH33X14BT T K

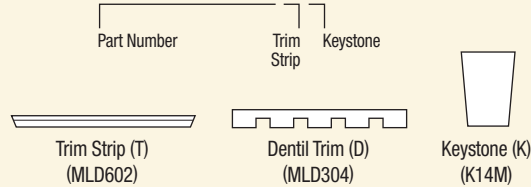

Note: A Keystone cannot be used when combining a Crosshead with a Pediment.

Part numbers in red indicate products with Bottom Trim, which add an inch to the height of the product.

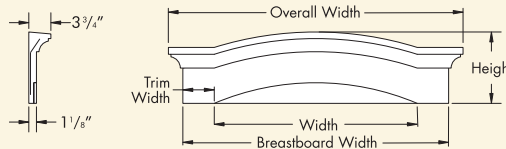

TIP: Window Crossheads can also be used in a Door Crosshead application.

Window Crosshead Segment

UNATTACHED ACCESSORIES

DIMENSIONS



Part Number	Width	Height	Trim Width	Breastboard Width	Overall Width	Keystone (Page 51 WD)
WCHSEG24X10	24"	10 3/8"	4 5/8"	33 1/4"	37 1/2"	K10SEG
WCHSEG28X10	28"	10 3/8"	4 5/8"	37 1/4"	41 1/2"	K10SEG

CHART CONTINUED ON FOLLOWING PAGE.

Window Crosshead Segment (continued)

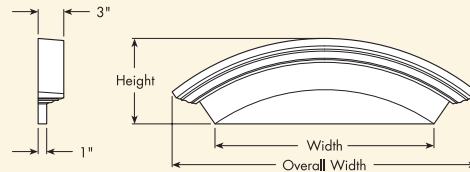

UNATTACHED ACCESSORIES

DIMENSIONS						
Part Number	Width	Height	Trim Width	Breastboard Width	Overall Width	Keystone (Page 51 WD)
WCHSEG30X10	29 7/8"	10 3/8"	4 5/8"	39 1/8"	43 3/8"	K10SEG
WCHSEG34X10	34"	10"	5"	44"	48 1/4"	K10SEG
WCHSEG36X10	36"	10 1/2"	4 1/2"	45"	49 1/4"	K10SEG
WCHSEG38X12	37 3/4"	12 1/8"	5 1/4"	48 1/4"	52 1/2"	—
WCHSEG43X10	43"	10 1/2"	2 1/2"	48"	52 1/4"	K10SEG
WCHSEG44X10	44"	10 3/8"	4 5/8"	53 1/4"	57 1/2"	K10SEG
WCHSEG60X10	60"	10 3/8"	4 5/8"	69 1/4"	73 1/2"	K10SEG
WCHSEG64X10	64"	10 3/8"	4 5/8"	73 1/4"	77 1/2"	K10SEG
WCHSEG72X10	72"	10 1/2"	4 1/2"	81"	85 1/4"	K10SEG
WCHSEG76X10	76"	10 3/8"	4 5/8"	85 1/4"	89 1/2"	K10SEG
WCHSEG80X10	80"	10"	4 5/8"	89 1/4"	93 1/2"	K10SEG
WCHSEG97X10	96 3/4"	10 3/8"	4 5/8"	106"	110 1/4"	K10SEG



TIP: Window Crossheads can also be used in a Door Crosshead application.

6" Window Crosshead Arch Solid
UNATTACHED ACCESSORIES
ATTACHED ACCESSORIES

DIMENSIONS					
Part Number	Width	Height	Overall Width	Keystone (Page 49 WD)	Keystone (Recessed Panel) (Page 49 WD)
WCH6ARS26X10	25 5/8"	10"	35 21/32"	K6M	KP6M
WCH6ARS34X10	34"	10"	42 7/8"	K6M	KP6M
WCH6ARS66X13	66"	13"	74 1/2"	K6M	KP6M

The following accessories are available pre-attached to this product. To order, simply add the corresponding letter (found below the accessory drawing in parenthesis) to the main product number. To order more than one attached accessory, list all the corresponding letters of the accessories you select to the main product number. All items with attached accessories are shipped from our facility within five working days and are non-returnable.

EXAMPLE: WCH6ARS66X13 K
 Part Number Keystone

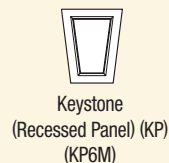

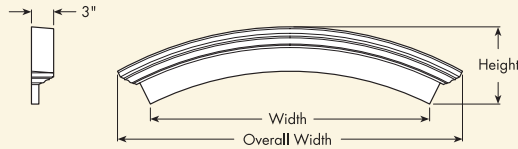

TIP: Window Crossheads can also be used in a Door Crosshead application.

6" Window Crosshead Arch

UNATTACHED ACCESSORIES

ATTACHED ACCESSORIES

DIMENSIONS

Part Number	Width	Height	Overall Width	Keystone (Page 49 WD)	Keystone (Recessed Panel) (Page 49 WD)
WCH6AR38X10	37 3/4"	10 7/16"	46 5/8"	K6M	KP6M

The following accessories are available pre-attached to this product. To order, simply add the corresponding letter (found below the accessory drawing in parenthesis) to the main product number. To order more than one attached accessory, list all the corresponding letters of the accessories you select to the main product number. All items with attached accessories are shipped from our facility within five working days and are non-returnable.

EXAMPLE: WCH6AR38X10 K
 Part Number Keystone

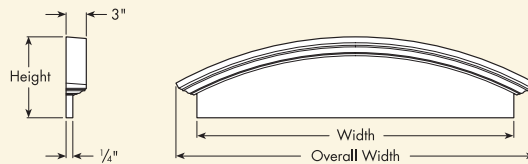
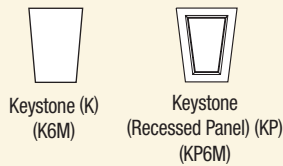

TIP: Window Crossheads can also be used in a Door Crosshead application.

6" Window Crosshead Arch - Pediment

DIMENSIONS

Part Number	Width	Height	Overall Width
WCH6ARP47X12	47"	12"	57 7/32"

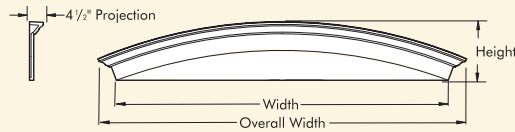

TIP: Window Crossheads can also be used in a Door Crosshead application.

9" Window Crosshead Arch Solid

UNATTACHED ACCESSORIES

ATTACHED ACCESSORIES

DIMENSIONS

Part Number	Width	Height	Overall Width	Accessories	
				Keystone (Page 49 WD)	Keystone (Recessed Panel) (Page 49 WD)
WCHARS33X14	33 5/8"	14"	—	K9M	KP9M
WCHARS36X13	36"	13"	49 13/64"	K9M	KP9M
WCHARS37X14	36 1/2"	14"	50 15/16"	K9M	KP9M
WCHARS38X14	38"	14 1/2"	52 25/32"	K9M	KP9M
WCHARS40X10	39 1/2"	10"	46 25/32"	K9M	KP9M
WCHARS41X12	41"	12"	52 3/32"	K9M	KP9M
WCHARS41X14	41 5/8"	14"	—	K9M	KP9M
WCHARS43X13	43"	13"	55 1/4"	K9M	KP9M
WCHARS43X17	43"	17"	59 11/32"	K9M	KP9M
WCHARS48X12	48"	12"	58 15/32"	K9M	KP9M
WCHARS48X16	48"	16"	62 17/32"	K9M	KP9M
WCHARS54X16	54"	16"	68 1/8"	K9M	KP9M
WCHARS64X14	64"	14"	75 13/32"	K9M	KP9M
WCHARS68X12	68"	12"	77 9/32"	K9M	KP9M
WCHARS68X16	68"	16"	80 13/16"	K9M	KP9M
WCHARS72X13	72"	13"	82 1/32"	K9M	KP9M
WCHARS74X20	74"	20"	89"	K9M	KP9M
WCHARS75X13	75"	13 3/8"	84 7/8"	K9M	KP9M
WCHARS79X17	79"	17"	91 23/32"	K9M	KP9M
WCHARS80X15	80"	15"	91 9/32"	K9M	KP9M
WCHARS84X16	84"	16"	95 23/32"	K9M	KP9M
WCHARS89X13	89"	13"	98 11/32"	K9M	KP9M
WCHARS89X17	89"	17"	101 3/32"	K9M	KP9M
WCHARS96X18	96"	18"	108 5/16"	K9M	KP9M
WCHARS96X19	96"	19"	108 7/8"	K9M	KP9M

The following accessories are available pre-attached to this product. To order, simply add the corresponding letter (found below the accessory drawing in parenthesis) to the main product number. To order more than one attached accessory, list all the corresponding letters of the accessories you select to the main product number. All items with attached accessories are shipped from our facility within five working days and are non-returnable.

EXAMPLE: WCHARS36X13 K

Part Number Keystone



Keystone (K)
(K9M)



Keystone
(Recessed Panel) (KP)
(KP9M)

CHART CONTINUED ON FOLLOWING PAGE.

9" Window Crosshead Arch Solid (continued)



UNATTACHED ACCESSORIES

ATTACHED ACCESSORIES

DIMENSIONS



The following accessories are available pre-attached to this product. To order, simply add the corresponding letter (found below the accessory drawing in parenthesis) to the main product number. To order more than one attached accessory, list all the corresponding letters of the accessories you select to the main product number. All items with attached accessories are shipped from our facility within five working days and are non-returnable.

Part Number	Width	Height	Overall Width	Keystone (Page 49 WD)	Keystone (Recessed Panel) (Page 49 WD)
WCHARS97X17	97"	17"	108 ¹¹ / ₁₆ "	K9M	KP9M
WCHARS99X18	99"	18"	111 ⁵ / ₃₂ "	K9M	KP9M
WCHARS101X13	101"	13"	110"	K9M	KP9M
WCHARS103X13	103"	13"	111 ³¹ / ₃₂ "	K9M	KP9M
WCHARS103X18	103"	18"	114 ³¹ / ₃₂ "	K9M	KP9M
WCHARS104X13	104"	13"	112 ¹⁵ / ₁₆ "	K9M	KP9M
WCHARS108X19	108"	19 ¹ / ₄ "	119 ²⁹ / ₃₂ "	K9M	KP9M

EXAMPLE: **WCHARS36X13 K**

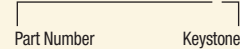

Keystone (K)
(K9M)



Keystone
(Recessed Panel) (KP)
(KP9M)

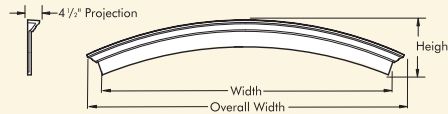

TIP: Window Crossheads can also be used in a Door Crosshead application.

9" Window Crosshead Arch

UNATTACHED ACCESSORIES

ATTACHED ACCESSORIES

DIMENSIONS



The following accessories are available pre-attached to this product. To order, simply add the corresponding letter (found below the accessory drawing in parenthesis) to the main product number. To order more than one attached accessory, list all the corresponding letters of the accessories you select to the main product number. All items with attached accessories are shipped from our facility within five working days and are non-returnable.

Part Number	Width	Height	Overall Width	Radius	Keystone (Page 49 WD)	Keystone (Recessed Panel) (Page 49 WD)
WCHAR50X17	50"	16 ¹ / ₂ "	65 ¹ / ₆₄ "	45 ²⁷ / ₆₄ "	K9M	KP9M
WCHAR63X19	63"	18 ¹ / ₂ "	78 ¹ / ₁₆ "	56 ³¹ / ₃₂ "	K9M	KP9M
WCHAR67X17	67"	17"	80 ²¹ / ₃₂ "	74 ¹ / ₈ "	K9M	KP9M
WCHAR67X18	66 ¹ / ₂ "	17 ²⁷ / ₃₂ "	81 ¹ / ₄ "	45 ²⁷ / ₆₄ "	K9M	KP9M
WCHAR68X16	68"	16"	80 ¹³ / ₁₆ "	86 ¹ / ₁₆ "	K9M	KP9M
WCHAR69X20	68 ¹ / ₂ "	19 ¹ / ₂ "	83 ¹¹ / ₁₆ "	61 ¹ / ₈ "	K9M	KP9M
WCHAR71.5X18	71 ¹ / ₂ "	18 ¹ / ₁₆ "	85 ¹ / ₂ "	75"	K9M	KP9M
WCHAR73X16	73"	15 ³ / ₄ "	85 ¹³ / ₁₆ "	102"	K9M	KP9M
WCHAR74X13	74"	13"	83 ¹⁵ / ₁₆ "	173 ¹ / ₈ "	K9M	KP9M
WCHAR74X17	74"	17"	87 ³ / ₃₂ "	89 ⁹ / ₁₆ "	K9M	KP9M

EXAMPLE: **WCHAR67X18 K**

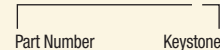

Note: A Keystone cannot be used when combining a Crosshead with a Pediment.



Keystone (K)
(K9M)



Keystone
(Recessed Panel) (KP)
(KP9M)

CHART CONTINUED ON FOLLOWING PAGE.

9" Window Crosshead Arch (continued)



UNATTACHED ACCESSORIES

ATTACHED ACCESSORIES

DIMENSIONS

Part Number	Width	Height	Overall Width	Radius	Keystone (Page 49 WD)	Keystone (Recessed Panel) (Page 49 WD)
WCHAR74X20	74"	20"	89"	67 ²³ / ₃₂ "	K9M	KP9M
WCHAR77X19	77"	19 ¹ / ₄ "	90 ²³ / ₃₂ "	77 ¹¹ / ₃₂ "	K9M	KP9M
WCHAR81X22	81"	21 ⁵ / ₈ "	96 ¹⁹ / ₃₂ "	75"	K9M	KP9M
WCHAR202X22	202"	22 ⁵ / ₁₆ "	212 ¹¹ / ₁₆ "	390"	K9M	KP9M



The following accessories are available pre-attached to this product. To order, simply add the corresponding letter (found below the accessory drawing in parenthesis) to the main product number. To order more than one attached accessory, list all the corresponding letters of the accessories you select to the main product number. All items with attached accessories are shipped from our facility within five working days and are non-returnable.

EXAMPLE: **WCHAR67X18 K**

Part Number Keystone

Note: A Keystone cannot be used when combining a Crosshead with a Pediment.



Keystone (K) (K9M)
Keystone (Recessed Panel) (KP) (KP9M)

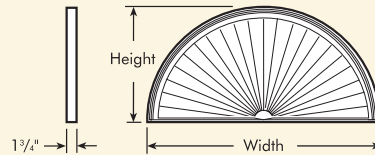

Sunburst Window Pediment Half Round

UNATTACHED ACCESSORIES

DIMENSIONS

Part Number	Width	Height	Keystone for Brickmould (Page 53 WD)	4F Arch Trim Flat (Page 30 WD)	6F Arch Trim Flat (Page 31 WD)	4M Arch Trim Decorative (Page 32 WD)	6M Arch Trim Decorative (Page 32 WD - 33 WD)	Deluxe Victorian Pediment (Page 61 WD)
SWDH24X12	24"	12"	KWM180M	AR24X4F	AR24X6F	AR24X4M	AR24X6M	—
SWDH28X14	28"	14"	KWM180M	AR28X4F	AR28X6F	AR28X4M	AR28X6M	—
SWDH30X15	30"	15"	KWM180M	AR30X4F	AR30X6F	AR30X4M	AR30X6M	—
SWDH32X16	32"	16"	KWM180M	AR32X4F	AR32X6F	AR32X4M	AR32X6M	—
SWDH33X17	33 ⁵ / ₈ "	16 ¹³ / ₁₆ "	KWM180M	AR33X4F	AR33X6F	AR33X4M	AR33X6M	—
SWDH36X18	36"	18"	KWM180M	AR36X4F	AR36X6F	AR36X4M	AR36X6M	—
SWDH37X19	37 ⁵ / ₈ "	18 ¹³ / ₁₆ "	KWM180M	AR37X4F	AR37X6F	AR37X4M	AR37X6M	—
SWDH40X20	40"	20"	KWM180M	AR40X4F	AR40X6F	AR40X4M	AR40X6M	DVP40
SWDH42X21	42"	21"	KWM180M	—	—	—	—	—
SWDH44X22	44"	22"	KWM180M	—	—	—	—	—

CHART CONTINUED ON FOLLOWING PAGE.

Sunburst Window Pediment Half Round (continued)



UNATTACHED ACCESSORIES

Part Number	DIMENSIONS							
	Width	Height	Keystone for Brickmould (Page 53 WD)	4F Arch Trim Flat (Page 30 WD)	6F Arch Trim Flat (Page 31 WD)	4M Arch Trim Decorative (Page 32 WD)	6M Arch Trim Decorative (Page 33 WD)	Deluxe Victorian Pediment (Page 61 WD)
SWDH48X24	48"	24"	KWM180M	AR48X4F	AR48X6F	AR48X4M	AR48X6M	—
SWDH52X26	52"	26"	KWM180M	—	—	—	—	—
SWDH56X28	56"	28"	KWM180M	AR56X4F	AR56X6F	AR56X4M	AR56X6M	—
SWDH60X30	60"	30"	KWM180M	AR60X4F	AR60X6F	—	AR60X6M	—
SWDH64X32	64"	32"	KWM180M	AR64X4F	—	—	—	—
SWDH68X34	68"	34"	KWM180M	—	—	—	—	—
SWDH72X36	72"	36"	KWM180M	AR72X4F	AR72X6F	AR72X4M	AR72X6M	—
SWDH76X23	77"	22 ³¹ / ₃₂ "	KWM180M	—	—	—	—	—
SWDH76X38	76"	38"	KWM180M	—	—	—	—	—
SWDH100X50	100"	50"	KWM180M	—	—	—	—	—

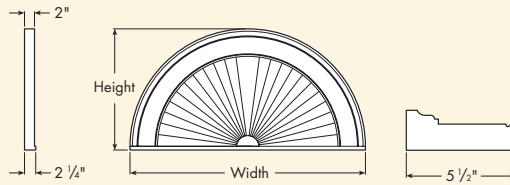

Sunburst Window Pediment Half Round with 5 1/2" Casing

UNATTACHED ACCESSORIES

Part Number	DIMENSIONS		
	Width	Height	Keystone for 5 1/2" Casing (Page 64 ML)
SWDH47X24M226	47"	24"	K226M

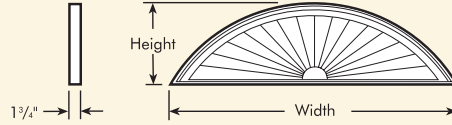

Sunburst Window Pediment Segment

UNATTACHED ACCESSORIES

DIMENSIONS



Part Number	Width	Height	Keystone for Brickmould <i>(Page 53 WD)</i>
SWDH32X9	32"	9 1/4"	KWM180M
SWDH34X8	33 5/8"	8 1/4"	KWM180M
SWDH36X9	36"	9"	KWM180M
SWDH40X10	40"	10"	KWM180M
SWDH46X13	46"	13"	KWM180M
SWDH48X13	48"	13"	KWM180M
SWDH54X13	54"	13"	KWM180M
SWDH60X13	60"	12 1/2"	KWM180M
SWDH64X13	64"	13"	KWM180M
SWDH68X14	68"	14"	KWM180M
SWDH72X14	72"	14"	KWM180M
SWDH76X15	76"	15"	KWM180M
SWDH78X16	78"	16"	KWM180M
SWDH80X15	80"	15"	KWM180M
SWDH96X17	96"	17"	KWM180M
SWDH100X17	100"	17 1/4"	KWM180M
SWDH104X18	104"	18"	KWM180M

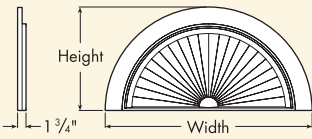

Sunburst Window Pediment with 4" Flat Trim

DIMENSIONS

Part Number	Width	Height	Overall Width
SWDH36X18-4F	36"	21 1/2"	43"

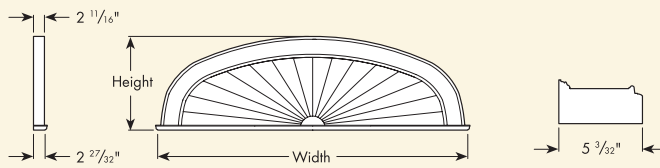

Elliptical Sunburst Window Pediment

DIMENSIONS

Part Number	Width	Height	Projection
ESWDH76X23	74 5/8"	22 7/8"	2 11/16"

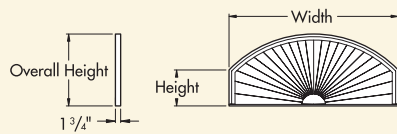

Eyebrow Sunburst Window Pediment

UNATTACHED ACCESSORIES

DIMENSIONS



Part Number	Width	Height	Overall Height	Projection	Keystone for Brickmould <i>(Page 53 WD)</i>
EBSWDH57X24	56 1/2"	12"	24"	1 3/4"	KWM180M

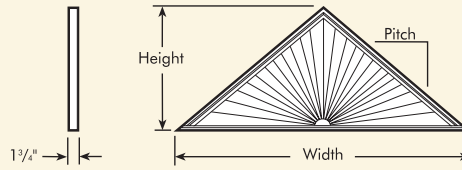

Peaked Sunburst Window Pediment

DIMENSIONS

Part Number	Width	Height	Pitch*
PSWDH24X12	24"	12"	12/12
PSWDH28X14	28"	14"	12/12
PSWDH30X15	30"	15"	12/12
PSWDH32X16	32"	16"	12/12
PSWDH33X17	33 ⁵ / ₈ "	16 ³ / ₄ "	12/12
PSWDH36X18	36"	18"	12/12
PSWDH37X19	37 ⁵ / ₈ "	18 ³ / ₄ "	12/12
PSWDH40X20	40"	20"	12/12
PSWDH44X22	44"	22"	12/12
PSWDH48X24	48"	24"	12/12
PSWDH52X26	52"	26"	12/12
PSWDH56X28	56"	28"	12/12
PSWDH60X30	60"	30"	12/12
PSWDH72X36	72"	36"	12/12
PSWDH76X38	76"	38"	12/12
PSWDH78X32	78"	32 ¹ / ₂ "	10/12
PSWDH78X39	78"	39"	12/12
PSWDH84X28	84"	28"	8/12
PSWDH88X33	88"	33"	9/12
PSWDH100X50	100"	50"	12/12

*Custom pitches available.

PITCH INFORMATION

Pitch indicates the incline of a roof as a ratio of the vertical rise to the horizontal run. It is properly expressed as X distance in 12 inches. For example: A roof that rises at a rate of seven inches for each foot of run is designated as having a 7/12 pitch.

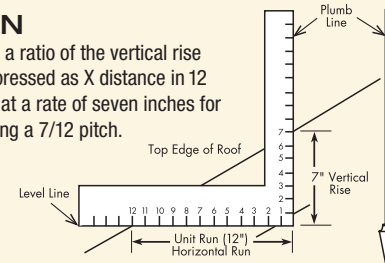

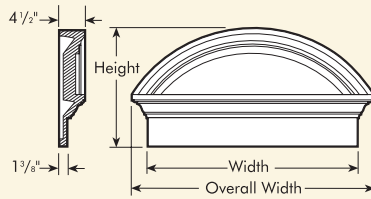

Combination Segment Arch Pediment

ATTACHED ACCESSORIES

DIMENSIONS

Part Number	Width	Overall Width	Height
CSAP33	33"	38 1/2"	19 1/2"
CSAP33BT	33"	38 1/2"	20 1/2"
CSAP36	36"	41 1/2"	20"
CSAP36BT	36"	41 1/2"	21"
CSAP38	38"	43 1/2"	20"
CSAP38BT	38"	43 1/2"	21"
CSAP43	42 1/2"	48"	21 1/4"
CSAP43BT	42 1/2"	48"	22 1/4"
CSAP48	48"	53 1/2"	22 1/2"
CSAP48BT	48"	53 1/2"	23 1/2"
CSAP64	64"	69 1/2"	25"
CSAP64BT	64"	69 1/2"	26"
CSAP65	65"	70 1/2"	28 3/8"
CSAP65BT	65"	70 1/2"	29 3/8"
CSAP84	84"	89 1/2"	28"
CSAP84BT	84"	89 1/2"	29"

The following accessories are available pre-attached to this product. To order, simply add the corresponding letter (found below the accessory drawing in parenthesis) to the main product number. To order more than one attached accessory, list all the corresponding letters of the accessories you select to the main product number. All items with attached accessories are shipped from our facility within five working days and are non-returnable.

EXAMPLE: CSAP33 T
 Part Number Trim Strip

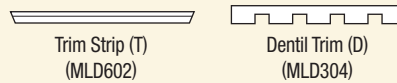

Part numbers in red indicate products with Bottom Trim, which add an inch to the height of the product.

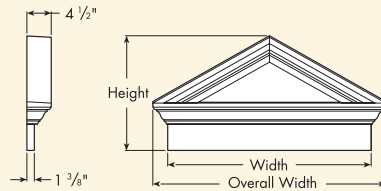

Combination Peaked Cap Pediment

ATTACHED ACCESSORIES

DIMENSIONS

Part Number	Width	Overall Width	Height
CCP37	37 5/8"	41 13/16"	20 1/2"
CCP37BT	37 5/8"	41 13/16"	21 1/2"
CCP60	60"	64 1/16"	28"
CCP60BT	60"	64 1/16"	29"

The following accessories are available pre-attached to this product. To order, simply add the corresponding letter (found below the accessory drawing in parenthesis) to the main product number. To order more than one attached accessory, list all the corresponding letters of the accessories you select to the main product number. All items with attached accessories are shipped from our facility within five working days and are non-returnable.

EXAMPLE: CCP37 T
 Part Number Trim Strip

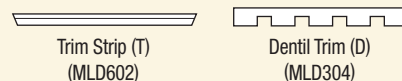

Part numbers in red indicate products with Bottom Trim, which add an inch to the height of the product.

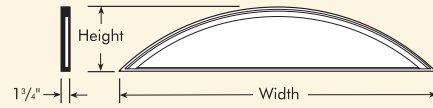

Plain Window Pediment Segment

DIMENSIONS

Part Number	Width	Height
PWDH36X9	36"	9 3/8"
PWDH64X14	64"	13 1/2"
PWDH72X14	72"	14"
PWDH100X17	100"	17 1/4"

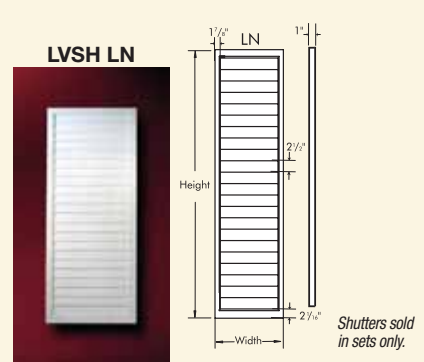
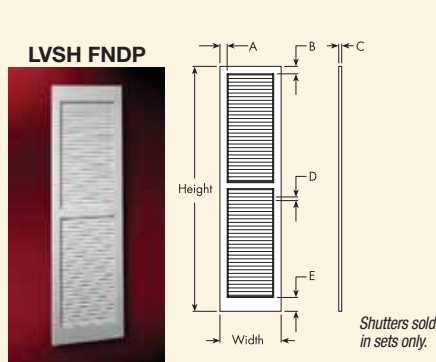
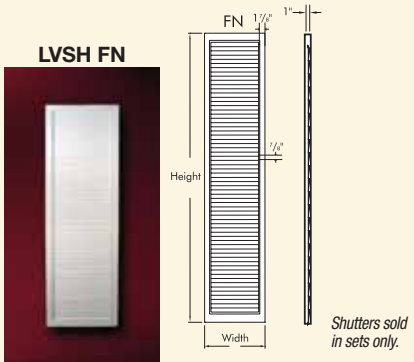

Louvered Shutter

FN STYLE			FNDP STYLE			LN STYLE		
DIMENSIONS			DIMENSIONS			DIMENSIONS		
Part Number	Width	Height	Part Number	Width	Height	Part Number	Width	Height
LVSH18X48FN	18"	48"	LVSH16X42FNDP	16"	42"	LVSH24X60LN	24"	60"
LVSH18X60FN	18"	60"	LVSH16X48FNDP	16"	48"	LVSH24X66LN	24"	66"
LVSH24X66FN	24"	66"	LVSH18X42FNDP	18"	42"			
LVSH24X78FN	24"	78"	LVSH18X55FNDP	18"	55"			
			LVSH18X67FNDP	18"	67"			
			LVSH18X72FNDP	18"	72"			
			LVSH32X72FNDP	32"	72"			

CHART CONTINUED ON FOLLOWING PAGE.

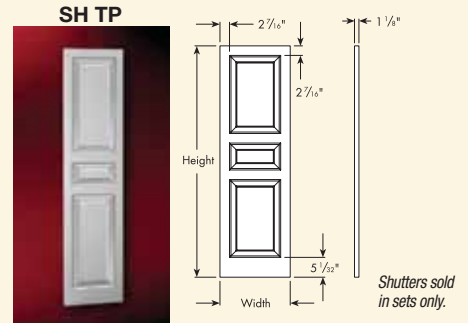
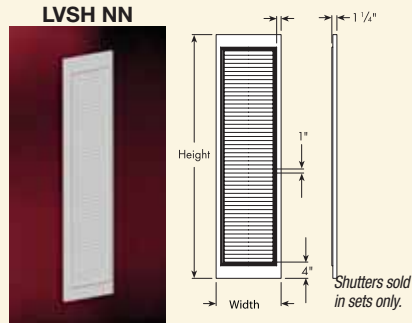
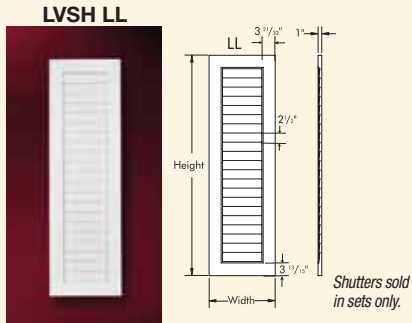

Louvered Shutter (continued)

LL STYLE			NN STYLE			TP STYLE		
DIMENSIONS			DIMENSIONS			DIMENSIONS		
Part Number	Width	Height	Part Number	Width	Height	Part Number	Width	Height
LVSH18X60LL	18"	60"	LVSH16X60NN	16"	60"	SH18X59TP	18"	59"
LVSH24X48LL	24"	48"	LVSH16X72NN	16"	72"			
LVSH24X60LL	24"	60"	LVSH18X96NN	18"	96"			
LVSH24X78LL	24"	78"	LVSH20X48NN	20"	48"			
			LVSH20X60NN	20"	60"			

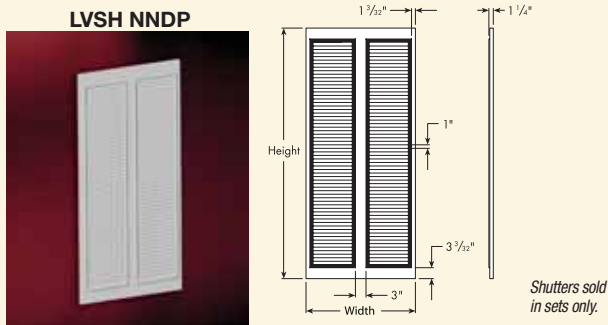



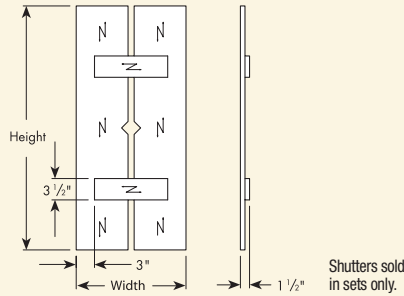

Louvered Shutter (continued)

NNDP STYLE		
DIMENSIONS		
Part Number	Width	Height
LVSH31X71NNDP	31"	71"



Two Plank Panel Shutter



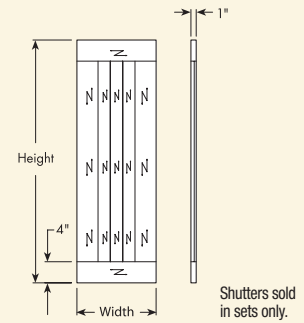

DIMENSIONS

Part Number	Width	Height
 SH2PD18X40S	18"	40"
 SH2PD18X60S	18"	60"
 SH2PD18X66S	18"	66"
 SH2PD24X48S	24"	48"
 SH2PD24X54S	24"	54"



Three Plank Panel Shutter

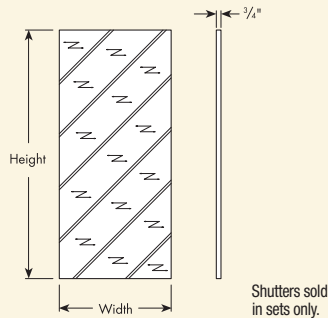

DIMENSIONS

Part Number	Width	Height
 SH3P15X46S	15"	46"
 SH3P18X40S	18"	40"
 SH3P18X66S	18"	66"
 SH3P24X54S	24"	54"



Diagonal V Groove Panel Shutter

DIMENSIONS

Part Number	Width	Height
 SHDV18X40S	18"	40"
 SHDV22X48S	22"	48"
 SHDV24X54S	24"	54"

 Indicates Woodgrain/Stainable Products

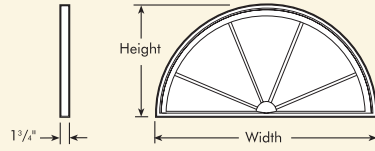

Half Round Spoked Pediment

UNATTACHED ACCESSORIES

DIMENSIONS



Part Number	Width	Height	Keystone for Brickmould <i>(Page 53 WD)</i>	4F Arch Trim Flat <i>(Page 30 WD)</i>	6F Arch Trim Flat <i>(Page 31 WD)</i>	4M Arch Trim Decorative <i>(Page 32 WD)</i>	6M Arch Trim Decorative <i>(Page 32 WD - 33 WD)</i>	Deluxe Victorian Pediment <i>(Page 61 WD)</i>
HRSP24X12	24"	12"	KWM180M	AR24X4F	AR24X6F	AR24X4M	AR24X6M	—
HRSP28X14	28"	14"	KWM180M	AR28X4F	AR28X6F	AR28X4M	AR28X6M	—
HRSP36X18	36"	18"	KWM180M	AR36X4F	AR36X6F	AR36X4M	AR36X6M	—
HRSP37X19	37 5/8"	18 13/16"	KWM180M	AR37X4F	AR37X6F	AR37X4M	AR37X6M	—
HRSP40X20	40"	20"	KWM180M	AR40X4F	AR40X6F	AR40X4M	AR40X6M	DVP40
HRSP44X22	44"	22"	KWM180M	—	—	—	—	—
HRSP48X24	48"	24"	KWM180M	AR48X4F	AR48X6F	AR48X4M	AR48X6M	—
HRSP52X26	52"	26"	KWM180M	—	—	—	—	—
HRSP56X28	56"	28"	KWM180M	AR56X4F	AR56X6F	AR56X4M	AR56X6M	—
HRSP60X30	60"	30"	KWM180M	AR60X4F	AR60X6F	—	AR60X6M	—
HRSP64X32	64"	32"	KWM180M	AR64X4F	—	—	—	—
HRSP72X36	72"	36"	KWM180M	AR72X4F	AR72X6F	AR72X4M	AR72X6M	—
HRSP78X39	78"	39"	KWM180M	—	—	—	—	—

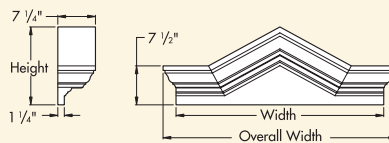

Crosshead Peaked Cap

DIMENSIONS

Part Number	Width	Height	Overall Width	Projection
CHPC40X15	40"	15"	45"	7 1/4"
CHPC40X15BT	40"	16"	45"	7 1/4"
CHPC120X15	120"	15"	125"	7 1/4"
CHPC120X15BT	120"	16"	125"	7 1/4"
CHPC197X15	197"	15"	202"	7 1/4"
CHPC197X15BT	197"	16"	202"	7 1/4"



Part numbers in red indicate products with Bottom Trim, which add an inch to the height of the product.

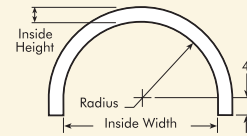
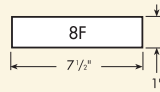
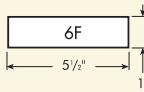
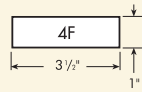

4F, 6F and 8F Arch Trim - Flat

UNATTACHED ACCESSORIES

DIMENSIONS



See Mouldings Section/Catalog

Part Number	Inside Width	Inside Height	Radius	Keystone (Page 51 WD)	Keystone (Recessed Panel) (Page 52 WD)	End Cap (Page 54 WD)	Half Round Sunburst Pediment (Page 20 WD - 21 WD)	Half Round Spoked Pediment (Page 29 WD)	Flat Trim Match (Page 3 ML)
AR24X4F	24 1/8"	16 1/16"	12 1/16"	K4TF	KP4TF	AR4C	SWDH24X12	HRSP24X12	FLT152
AR25X4F	25 5/8"	16 13/16"	12 13/16"	K4TF	KP4TF	AR4C	—	—	FLT152
AR27X4F	27 1/2"	17 3/4"	13 3/4"	K4TF	KP4TF	AR4C	—	—	FLT152
AR28X4F	28 1/2"	18 1/4"	14 1/4"	K4TF	KP4TF	AR4C	SWDH28X14	HRSP28X14	FLT152
AR29X4F	29 5/8"	18 13/16"	14 13/16"	K4TF	KP4TF	AR4C	—	—	FLT152
AR30X4F	30 3/4"	19 3/8"	15 3/8"	K4TF	KP4TF	AR4C	SWDH30X15	—	FLT152
AR31X4F	31 1/2"	19 3/4"	15 3/4"	K4TF	KP4TF	AR4C	—	—	FLT152
AR32X4F	32"	20"	16"	K4TF	KP4TF	AR4C	SWDH32X16	—	FLT152
AR33X4F	33 5/8"	20 13/16"	16 13/16"	K4TF	KP4TF	AR4C	SWDH33X17	—	FLT152
AR35X4F	35 1/2"	21 3/4"	17 3/4"	K4TF	KP4TF	AR4C	—	—	FLT152
AR36X4F	36"	22"	18"	K4TF	KP4TF	AR4C	SWDH36X18	HRSP36X18	FLT152
AR37X4F	37 5/8"	22 13/16"	18 13/16"	K4TF	KP4TF	AR4C	SWDH37X19	HRSP37X19	FLT152
AR40X4F	40"	24"	20"	K4TF	KP4TF	AR4C	SWDH40X20	HRSP40X20	FLT152
AR41X4F	41 5/8"	24 13/16"	20 13/16"	K4TF	KP4TF	AR4C	—	—	FLT152
AR48X4F	48"	28"	24"	K4TF	KP4TF	AR4C	SWDH48X24	HRSP48X24	FLT152
AR54X4F	54"	31"	27"	K4TF	KP4TF	AR4C	—	—	FLT152
AR56X4F	56 1/2"	32 1/4"	28 1/4"	K4TF	KP4TF	AR4C	SWDH56X28	HRSP56X28	FLT152
AR60X4F	60"	34"	30"	K4TF	KP4TF	AR4C	SWDH60X30	HRSP60X30	FLT152
AR61X4F	61 1/2"	34 3/4"	30 3/4"	K4TF	KP4TF	AR4C	—	—	FLT152
AR64X4F	64"	36"	32"	K4TF	KP4TF	AR4C	SWDH64X32	HRSP64X32	FLT152
AR67X4F	67 5/16"	37 21/32"	33 21/32"	K4TF	KP4TF	AR4C	—	—	FLT152
AR72X4F	72"	40"	36"	K4TF	KP4TF	AR4C	SWDH72X36	HRSP72X36	FLT152
AR75X4F	75 5/16"	41 21/32"	37 21/32"	K4TF	KP4TF	AR4C	—	—	FLT152

CHART CONTINUED ON FOLLOWING PAGE.

4F, 6F and 8F Arch Trim - Flat (continued)



UNATTACHED ACCESSORIES

DIMENSIONS



See Mouldings Section/Catalog

Part Number	Inside Width	Overall Height	Radius	Keystone (Page 52 WD)	Keystone (Recessed Panel) (Page 52 WD)	End Cap (Page 54 WD)	Half Round Sunburst Pediment (Page 20 WD - 21 WD)	Half Round Spoked Pediment (Page 29 WD)	Flat Trim Match (Page 3 ML)
AR24X6F	24 1/8"	16 1/16"	12 1/16"	K6TF	KP6TF	AR6C	SWDH24X12	HRSP24X12	FLT159
AR25X6F	25 5/8"	16 13/16"	12 13/16"	K6TF	KP6TF	AR6C	—	—	FLT159
AR27X6F	27 1/2"	17 3/4"	13 3/4"	K6TF	KP6TF	AR6C	—	—	FLT159
AR28X6F	28 3/8"	20 3/16"	14 3/16"	K6TF	KP6TF	AR6C	SWDH28X14	HRSP28X14	FLT159
AR29X6F	29 5/8"	18 13/16"	14 13/16"	K6TF	KP6TF	AR6C	—	—	FLT159
AR30X6F	30 3/4"	19 3/8"	15 3/8"	K6TF	KP6TF	AR6C	SWDH30X15	—	FLT159
AR31X6F	31 1/2"	19 3/4"	15 3/4"	K6TF	KP6TF	AR6C	—	—	FLT159
AR32X6F	32"	20"	16"	K6TF	KP6TF	AR6C	SWDH32X16	—	FLT159
AR33X6F	33 5/8"	20 13/16"	16 13/16"	K6TF	KP6TF	AR6C	SWDH33X17	—	FLT159
AR35X6F	35 1/2"	21 3/4"	17 3/4"	K6TF	KP6TF	AR6C	—	—	FLT159
AR36X6F	36"	22"	18"	K6TF	KP6TF	AR6C	SWDH36X18	HRSP36X18	FLT159
AR37X6F	37 5/8"	22 13/16"	18 13/16"	K6TF	KP6TF	AR6C	SWDH37X19	HRSP37X19	FLT159
AR40X6F	40"	24"	20"	K6TF	KP6TF	AR6C	SWDH40X20	HRSP40X20	FLT159
AR41X6F	41 5/8"	24 13/16"	20 13/16"	K6TF	KP6TF	AR6C	—	—	FLT159
AR48X6F	48"	28"	24"	K6TF	KP6TF	AR6C	SWDH48X24	HRSP48X24	FLT159
AR54X6F	54"	31"	27"	K6TF	KP6TF	AR6C	—	—	FLT159
AR56X6F	56 1/2"	32 1/4"	28 1/4"	K6TF	KP6TF	AR6C	SWDH56X28	HRSP56X28	FLT159
AR60X6F	60"	34"	30"	K6TF	KP6TF	AR6C	SWDH60X30	HRSP60X30	FLT159
AR67X6F	67 5/16"	37 21/32"	33 21/32"	K6TF	KP6TF	AR6C	—	—	FLT159
AR72X6F	72"	40"	36"	K6TF	KP6TF	AR6C	SWDH72X36	HRSP72X36	FLT159
AR75X6F	75 5/16"	41 21/32"	37 21/32"	K6TF	KP6TF	AR6C	—	—	FLT159
AR83X6F	83"	45 1/2"	41 1/2"	K6TF	KP6TF	AR6C	—	—	FLT159
AR37X8F	36 5/8"	22 15/16"	18 15/16"	K8TF	KP8TF	—	—	—	FLT162
AR52X8F	52"	30"	26"	K8TF	KP8TF	—	SWDH52X26	HRSP52X26	FLT162

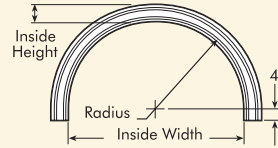
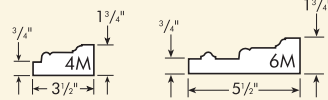

4M and 6M Arch Trim - Decorative

UNATTACHED ACCESSORIES

Part Number	DIMENSIONS			Keystone (Page 52 WD)	Keystone (Recessed Panel) (Page 52 WD)	End Cap (Page 54 WD)	Half Round Sunburst Pediment (Page 20 WD - 21 WD)	Half Round Spoked Pediment (Page 29 WD)	Mouldings Match (Page 7 ML)
	Inside Width	Inside Height	Radius						
AR24X4M	24"	16"	12"	K4TM	KP4TM	AR4C	SWDH24X12	HRSP24X12	MLD215
AR25X4M	25 5/8"	16 13/16"	12 13/16"	K4TM	KP4TM	AR4C	—	—	MLD215
AR27X4M	27 1/2"	17 3/4"	13 3/4"	K4TM	KP4TM	AR4C	—	—	MLD215
AR28X4M	28 3/4"	18 3/8"	14 3/8"	K4TM	KP4TM	AR4C	SWDH28X14	HRSP28X14	MLD215
AR29X4M	29 5/8"	18 13/16"	14 13/16"	K4TM	KP4TM	AR4C	SWDH28X14	HRSP28X14	MLD215
AR32X4M	32"	20"	16"	K4TM	KP4TM	AR4C	SWDH32X16	—	MLD215
AR33X4M	33 5/8"	20 13/16"	16 13/16"	K4TM	KP4TM	AR4C	SWDH33X17	—	MLD215
AR35X4M	35 1/2"	21 3/4"	17 3/4"	K4TM	KP4TM	AR4C	—	—	MLD215
AR36X4M	36"	22"	18"	K4TM	KP4TM	AR4C	SWDH36X18	HRSP36X18	MLD215
AR37X4M	37 5/8"	22 13/16"	18 13/16"	K4TM	KP4TM	AR4C	SWDH37X19	HRSP37X19	MLD215
AR40X4M	40"	24"	20"	K4TM	KP4TM	AR4C	SWDH40X20	HRSP40X20	MLD215
AR41X4M	41 5/8"	24 13/16"	20 13/16"	K4TM	KP4TM	AR4C	—	—	MLD215
AR48X4M	48"	28"	24"	K4TM	KP4TM	AR4C	SWDH48X24	HRSP48X24	MLD215
AR54X4M	54"	31"	27"	K4TM	KP4TM	AR4C	—	—	MLD215
AR56X4M	56 1/2"	32 1/4"	28 1/4"	K4TM	KP4TM	AR4C	SWDH56X28	HRSP56X28	MLD215
AR67X4M	67 5/16"	37 21/32"	33 21/32"	K4TM	KP4TM	AR4C	—	—	MLD215
AR72X4M	71 7/8"	39 15/16"	35 15/16"	K4TM	KP4TM	AR4C	SWDH72X36	HRSP72X36	MLD215
AR24X6M	24"	16"	12"	K6TM	KP6TM	AR6C	SWDH24X12	HRSP24X12	MLD220
AR25X6M	25 5/8"	16 13/16"	12 13/16"	K6TM	KP6TM	AR6C	—	—	MLD220
AR27X6M	27 1/2"	17 3/4"	13 3/4"	K6TM	KP6TM	AR6C	—	—	MLD220
AR28X6M	28 3/8"	18 3/16"	14 3/16"	K6TM	KP6TM	AR6C	SWDH28X14	HRSP28X14	MLD220

CHART CONTINUED ON FOLLOWING PAGE.

4M and 6M Arch Trim - Decorative (continued)



UNATTACHED ACCESSORIES

DIMENSIONS



See Mouldings Section/Catalog

Part Number	Inside Width	Inside Height	Radius	Keystone <i>(Page 52 WD)</i>	Keystone (Recessed Panel) <i>(Page 52 WD)</i>	End Cap <i>(Page 54 WD)</i>	Half Round Sunburst Pediment <i>(Page 20 WD - 21 WD)</i>	Half Round Spoked Pediment <i>(Page 29 WD)</i>	Moulding Match <i>(Page 7 ML)</i>
AR29X6M	29 5/8"	18 13/16"	14 13/16"	K6TM	KP6TM	AR6C	SWDH30X15	—	MLD220
AR33X6M	33 5/8"	20 13/16"	16 13/16"	K6TM	KP6TM	AR6C	SWDH33X17	—	MLD220
AR35X6M	35 1/2"	21 3/4"	17 3/4"	K6TM	KP6TM	AR6C	—	—	MLD220
AR36X6M	36"	22 1/32"	18 1/32"	K6TM	KP6TM	AR6C	SWDH36X18	HRSP36X18	MLD220
AR37X6M	37 5/8"	22 13/16"	18 13/16"	K6TM	KP6TM	AR6C	SWDH37X19	HRSP37X19	MLD220
AR40X6M	40"	24"	20"	K6TM	KP6TM	AR6C	SWDH40X20	HRSP40X20	MLD220
AR41X6M	41 5/8"	24 13/16"	20 13/16"	K6TM	KP6TM	AR6C	—	—	MLD220
AR43X6M	43"	25 1/2"	21 1/2"	K6TM	KP6TM	AR6C	—	—	MLD220
AR44X6M	44"	26"	22"	K6TM	KP6TM	AR6C	SWDH44X22	HRSP44X22	MLD220
AR48X6M	48"	28"	24"	K6TM	KP6TM	AR6C	SWDH48X24	HRSP48X24	MLD220
AR54X6M	54"	31"	27"	K6TM	KP6TM	AR6C	—	—	MLD220
AR56X6M	56 1/2"	32 1/4"	28 1/4"	K6TM	KP6TM	AR6C	SWDH56X28	HRSP56X28	MLD220
AR60X6M	60"	34"	30"	K6TM	KP6TM	AR6C	SWDH60X30	HRSP60X30	MLD220
AR63X6M	63"	34 1/2"	31 1/2"	K6TM	KP6TM	AR6C	—	—	MLD220
AR66X6M	66"	37"	33"	K6TM	KP6TM	AR6C	—	—	MLD220
AR67X6M	67 5/16"	37 21/32"	33 21/32"	K6TM	KP6TM	AR6C	—	—	MLD220
AR72X6M	72"	40"	36"	K6TM	KP6TM	AR6C	SWDH72X36	HRSP72X36	MLD220
AR96X6M	96"	52"	48"	K6TM	KP6TM	AR6C	—	—	MLD220

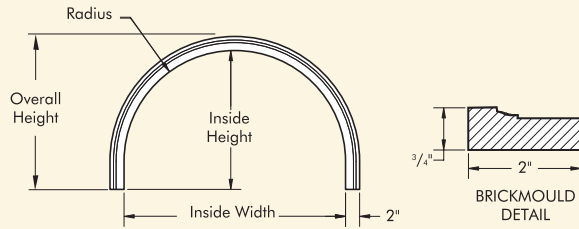

Arch Trim, Brickmould

UNATTACHED ACCESSORIES

DIMENSIONS



See Mouldings Section/Catalog

Part Number	Inside Width	Inside Height	Overall Height	Radius	Moulding Match (Page 5 ML)
ARWM181-32	31 1/2"	19 3/4"	21 3/4"	15 3/4"	MLDWM181-16
ARWM181-40	39 1/2"	23 3/4"	25 3/4"	19 3/4"	MLDWM181-16
ARWM181-44	43 1/2"	25 3/4"	27 3/4"	21 3/4"	MLDWM181-16
ARWM181-56	55 1/2"	31 3/4"	33 3/4"	26 3/4"	MLDWM181-16
ARWM181-68	67 1/2"	37 3/4"	39 3/4"	33 3/4"	MLDWM181-16

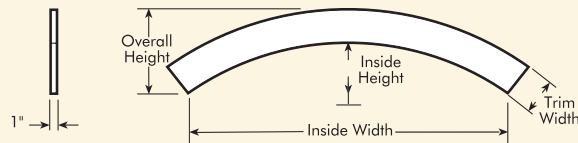

4F Arch Segment Trim - Flat

UNATTACHED ACCESSORIES

DIMENSIONS

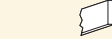

See Mouldings Section/Catalog

Part Number	Inside Width	Inside Height	Overall Height	Trim Width	Radius	Flat Keystone (Page 51 WD)	Keystone (Recessed Panel) (Page 52 WD)	Moulding Match (Page 3 ML)
ARSEG35X6X4F	35 1/4"	6"	9 1/2"	3 1/2"	28 7/8"	K4TF	KP4TF	FLT152
ARSEG54X8X4F	54 15/16"	8 5/8"	12 1/8"	3 1/2"	48 1/16"	K4TF	KP4TF	FLT152
ARSEG64X10X4F	63 7/8"	10"	13 1/2"	3 1/2"	56"	K4TF	KP4TF	FLT152
ARSEG66X9X4F	66 3/16"	9 15/16"	13 7/16"	3 1/2"	60 1/16"	K4TF	KP4TF	FLT152
ARSEG70X9X4F	70 5/8"	9 1/2"	13"	3 1/2"	70 3/8"	K4TF	KP4TF	FLT152
ARSEG78X11X4F	78 5/16"	11 9/16"	15 1/16"	3 1/2"	72 1/16"	K4TF	KP4TF	FLT152
ARSEG98X13X4F	98 13/16"	13 11/16"	17 3/16"	3 1/2"	96 1/16"	K4TF	KP4TF	FLT152

For special order sizes, refer to the order form in the Price Catalog.

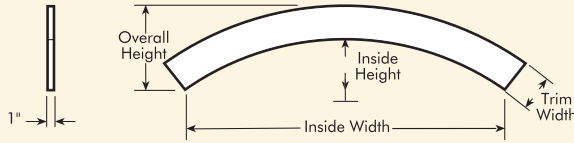

5F and 6F Arch Segment Trim - Flat

UNATTACHED ACCESSORIES

DIMENSIONS



See Mouldings Section/Catalog

Part Number	Inside Width	Inside Height	Overall Height	Trim Width	Radius	Flat Keystone (Page 52 WD)	Keystone (Recessed Panel) (Page 52 WD)	Moulding Match (Page 3 ML)
ARSEG48X3X5F	48"	2 11/16"	7 11/16"	5"	107 5/8"	K5TF	—	—
ARSEG78X8X5F	78"	7 5/16"	12 5/16"	5"	107 5/8"	K5TF	—	—
ARSEG80X8X5F	80"	7 11/16"	12 11/16"	5"	107 5/8"	K5TF	—	—
ARSEG90X10X5F	90"	9 7/8"	14 7/8"	5"	107 5/8"	K5TF	—	—
ARSEG54X8X6F	54 15/16"	8 5/8"	14 1/8"	5 1/2"	48 1/16"	K6TF	KP6TF	FLT159
ARSEG60X8X6F	60"	8"	13 1/2"	5 1/2"	60 1/4"	K6TF	KP6TF	FLT159
ARSEG63X8X6F	63"	8"	13 1/2"	5 1/2"	66"	K6TF	KP6TF	FLT159
ARSEG66X9X6F	66 3/16"	9 15/16"	15 7/16"	5 1/2"	60 1/16"	K6TF	KP6TF	FLT159
ARSEG78X11X6F	78 9/16"	11 9/16"	17 1/16"	5 1/2"	72 1/16"	K6TF	KP6TF	FLT159
ARSEG96X19X6F	96"	19 3/32"	24 19/32"	5 1/2"	69 7/8"	K6TF	KP6TF	FLT159
ARSEG98X13X6F	98 13/16"	13 11/16"	19 3/16"	5 1/2"	96 1/16"	K6TF	KP6TF	FLT159

For special order sizes, refer to the order form in the Price Catalog.

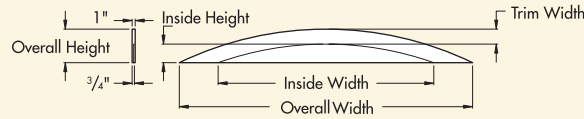

5F Arch Segment Solid - Flat

UNATTACHED ACCESSORIES

DIMENSIONS



Part Number	Inside Width	Inside Height	Overall Width	Overall Height	Projection	Trim Width	Flat Keystone (Page 52 WD)
ARSEGS36X1X5F	36"	1 1/2"	75 1/2"	6 1/2"	1"	5"	K5TF
ARSEGS72X6X5F	72"	6 3/16"	97 15/16"	11 3/16"	1"	5"	K5TF
ARSEGS108X15X5F	108"	14 1/2"	126 3/4"	19 1/2"	1"	5"	K5TF

For special order sizes, refer to the order form in the Price Catalog.

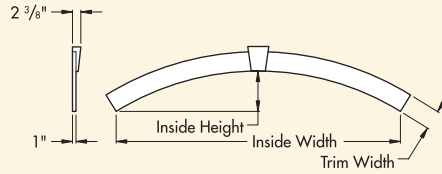

Arch Segment Flat with Keystone

UNATTACHED ACCESSORIES

DIMENSIONS

See Mouldings Section/Catalog



Part Number	Inside Width	Inside Height	Trim Width	Moulding Match (Page 3 ML)	End Cap (Page 54 WD)
AR81X12X6FK	81"	18 3/8"	5 1/2"	FLT159	AR6C

For special order sizes, refer to the order form in the Price Catalog.

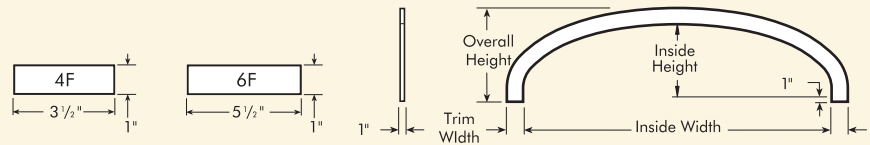

4F and 6F Arch Elliptical Trim - Flat

UNATTACHED ACCESSORIES

DIMENSIONS



See Mouldings Section/Catalog

Part Number	Inside Width	Inside Height	Overall Height	Trim Width	Keystone (Page 51 WD - 52 WD)	Keystone (Recessed Panel) (Page 52 WD)	End Cap (Page 54 WD)	Flat Trim Match (Page 3 ML)
AR72X4FET	71 3/8"	13 5/16"	16 13/16"	3 1/2"	K4TF	KP4TF	AR4C	FLT152
AR96X4FET	95 7/16"	8 1/2"	21"	3 1/2"	K4TF	KP4TF	AR4C	FLT152
AR76X24X4FET	76 5/16"	21 1/16"	24 5/16"	3 1/2"	K4TF	KP4TF	AR4C	FLT152
AR100X20X4FET	99 19/32"	17"	20 1/2"	3 1/2"	K4TF	KP4TF	AR4C	FLT152
AR112X24X4FET	112 5/16"	20 1/4"	23 3/4"	3 1/2"	K4TF	KP4TF	AR4C	FLT152
AR72X6FET	71 3/8"	11 5/16"	16 13/16"	5 1/2"	K6TF	KP6TF	AR6C	FLT159
AR96X6FET	95 7/16"	15 1/2"	21"	5 1/2"	K6TF	KP6TF	AR6C	FLT159

For special order sizes, refer to the order form in the Price Catalog.

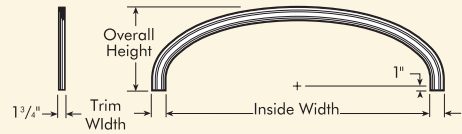
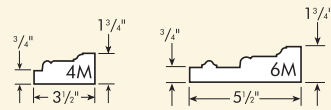

4M and 6M Arch Elliptical Trim - Decorative

UNATTACHED ACCESSORIES

DIMENSIONS



See Mouldings Section/Catalog

Part Number	Inside Width	Inside Height	Overall Height	Trim Width	Keystone <i>(Page 51 WD)</i>	Keystone (Recessed Panel) <i>(Page 52 WD)</i>	End Cap <i>(Page 54 WD)</i>	Decorative Moulding Match <i>(Page 7 ML)</i>
AR48X4MET	47 1/2"	11 3/4"	15 1/4"	3 1/2"	K4TM	KP4TM	AR4C	MLD215
AR72X4MET	71 3/8"	13 5/16"	16 13/16"	3 1/2"	K4TM	KP4TM	AR4C	MLD215
AR96X4MET	95 7/16"	17 1/2"	21"	3 1/2"	K4TM	KP4TM	AR4C	MLD215
AR56X6MET	56"	18 5/16"	23 15/16"	5 1/2"	K6TM	KP6TM	AR6C	MLD220
AR72X6MET	71 3/8"	11 5/16"	16 13/16"	5 1/2"	K6TM	KP6TM	AR6C	MLD220
AR96X6MET	95 7/16"	15 1/2"	21"	5 1/2"	K6TM	KP6TM	AR6C	MLD220

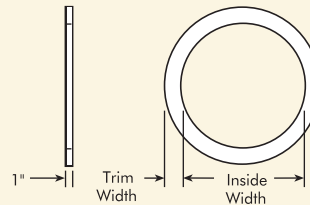
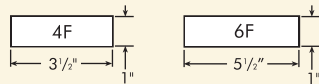

4F and 6F Circle Trim - Flat

UNATTACHED ACCESSORIES

DIMENSIONS



Part Number	Inside Width	Trim Width	Keystone <i>(Page 51 WD - 52 WD)</i>	Keystone (Recessed Panel) <i>(Page 52 WD)</i>
CIR24X4F	24 1/4"	3 1/2"	K4TF	KP4TF
CIR28X4F	28 1/2"	3 1/2"	K4TF	KP4TF
CIR36X4F	36 1/16"	3 1/2"	K4TF	KP4TF
CIR24X6F	24 1/4"	5 1/2"	K6TF	KP6TF
CIR28X6F	28 1/2"	5 1/2"	K6TF	KP6TF
CIR36X6F	36 1/16"	5 1/2"	K6TF	KP6TF

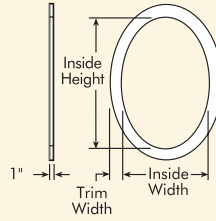
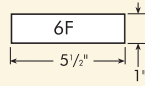
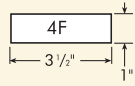

4F and 6F Oval Trim - Flat

UNATTACHED ACCESSORIES

DIMENSIONS

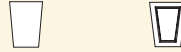

Part Number	Inside Width	Inside Height	Trim Width	Keystone (Page 51 WD - 52 WD)	Keystone (Recessed Panel) (Page 52 WD)
OV20X28X4F	19 7/8"	28 1/2"	3 1/2"	K4TF	KP4TF
OV24X36X4F	24 1/8"	36 1/16"	3 1/2"	K4TF	KP4TF
OV25X34X4F	25 1/2"	34"	3 1/2"	K4TF	KP4TF
OV36X56X4F	36 1/8"	56 5/8"	3 1/2"	K4TF	KP4TF
OV20X28X6F	19 7/8"	28 1/2"	5 1/2"	K6TF	KP6TF
OV24X36X6F	24 1/8"	36 1/16"	5 1/2"	K6TF	KP6TF
OV36X56X6F	36 1/8"	56 5/8"	5 1/2"	K6TF	KP6TF

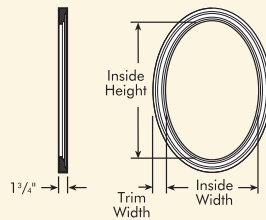
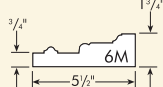
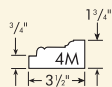

4M and 6M Oval Trim - Decorative

UNATTACHED ACCESSORIES

DIMENSIONS

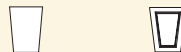

Part Number	Inside Width	Inside Height	Trim Width	Keystone (Page 52 WD)	Keystone (Recessed Panel) (Page 52 WD)
OV20X28X4M	19 7/8"	28 1/2"	3 1/2"	K4TM	KP4TM
OV24X36X4M	24 1/8"	36 1/16"	3 1/2"	K4TM	KP4TM
OV36X56X4M	36 1/8"	56 5/8"	3 1/2"	K4TM	KP4TM
OV20X28X6M	19 7/8"	28 1/2"	5 1/2"	K6TM	KP6TM
OV24X36X6M	24 1/8"	36 1/16"	5 1/2"	K6TM	KP6TM
OV36X56X6M	36 1/8"	56 5/8"	5 1/2"	K6TM	KP6TM

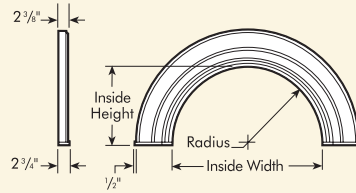

10" Decorative Arch with End Caps

UNATTACHED ACCESSORIES

DIMENSIONS



Part Number	Inside Width	Inside Height	Radius	Keystone <i>(Page 53 WD)</i>	10" Pilaster Match <i>(Page 74 WD)</i>	Half Round Sunburst Pediment <i>(Page 20 WD - 21 WD)</i>	Half Round Spoked Pediment <i>(Page 29 WD)</i>
AR24X10MC	24"	12 3/4"	12"	K10TM	PIL10X96A PIL10X192A	SWDH24X12*	HRSP24X12
AR32X10MC	32"	16 3/4"	16"	K10TM	PIL10X96A PIL10X192A	SWDH32X16*	—
AR33X10MC	33 5/8"	17 9/16"	16 13/16"	K10TM	PIL10X96A PIL10X192A	SWDH33X17	—
AR36X10MC	36"	18 3/4"	18"	K10TM	PIL10X96A PIL10X192A	SWDH36X18*	HRSP36X18
AR37X10MC	37 5/8"	19 9/16"	18 13/16"	K10TM	PIL10X96A PIL10X192A	SWDH37X19	HRSP37X19
AR40X10MC	40"	20 3/4"	20"	K10TM	PIL10X96A PIL10X192A	SWDH40X20*	HRSP40X20
AR44X10MC	44"	22 3/4"	22"	K10TM	PIL10X96A PIL10X192A	SWDH44X22	HRSP44X22
AR48X10MC	48"	24 3/4"	24"	K10TM	PIL10X96A PIL10X192A	SWDH48X24	HRSP48X24
AR52X10MC	52"	26 3/4"	26"	K10TM	PIL10X96A PIL10X192A	SWDH52X26	HRSP52X26

*Can be ordered as 10" Decorative Arch with Sunburst and Keystone (Page 58 WD).

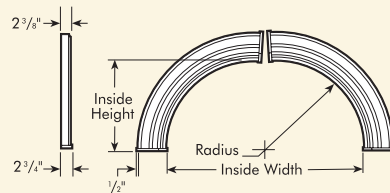

(Field trim End Caps at top of Arch) Ships in two pieces - Keystone recommended.

10" Decorative Arch with End Caps

UNATTACHED ACCESSORIES

DIMENSIONS



Part Number	Inside Width	Inside Height	Radius	Keystone <i>(Page 53 WD)</i>	10" Pilaster Match <i>(Page 74 WD)</i>	Half Round Sunburst Pediment <i>(Page 20 WD - 21 WD)</i>	Half Round Spoked Pediment <i>(Page 29 WD)</i>
AR60X10MC	60"	30 3/4"	30"	K10TM	PIL10X96A PIL10X192A	SWDH60X30	HRSP60X30
AR62X10MC	62"	31 3/4"	31"	K10TM	PIL10X96A PIL10X192A	—	—
AR64X10MC	64"	32 3/4"	32"	K10TM	PIL10X96A PIL10X192A	SWDH64X32	HRSP64X32

CHART CONTINUED ON FOLLOWING PAGE.