

7" Balustrade System
Baluster - Riley (RY)

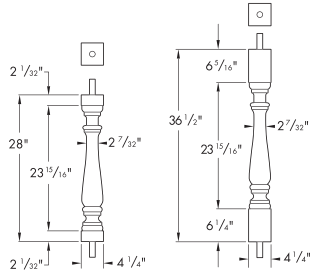

Part Number

BAL4X28RY*

BAL4X37RY

Maximum Center-to-Center Distance To Meet 4" Rule. (See Page 2 BL For Details)

6 5/32"

6 5/32"

*Cannot be used for stair applications.

7" Balustrade System
Baluster - Square (SQ)

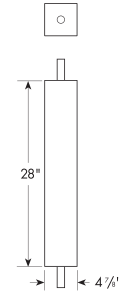

Part Number

BAL5X28SQ

Maximum Center-to-Center Distance To Meet 4" Rule. (See Page 2 BL For Details)

8 13/16"

7" Balustrade System
Baluster - Rosedale (RL)

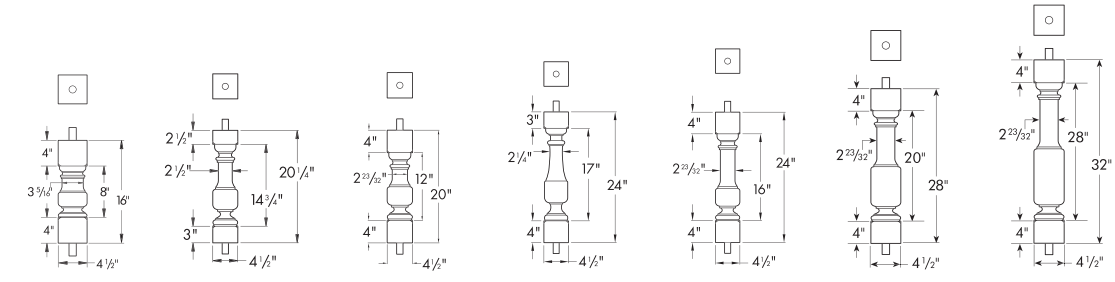

Part Number

BAL5X16RL

BAL5X20RLOB*

BAL5X20RL

BAL5X24RLOB*

BAL5X24RL

BAL5X28RL

BAL5X32RL

Maximum Center-to-Center Distance To Meet 4" Rule. (See Page 2 BL For Details)

7 1/4"

6 7/16"

6 5/8"

6 3/16"

6 5/8"

6 5/8"

6 5/8"

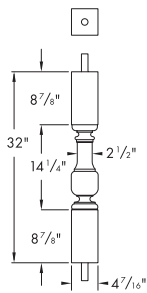

Part Number

BAL5X32RLTB

Maximum Center-to-Center Distance To Meet 4" Rule. (See Page 2 BL For Details)

6 7/16"

*Cannot be used for stair applications.

7" Balustrade System Baluster - Trinity (TY)



Part Number

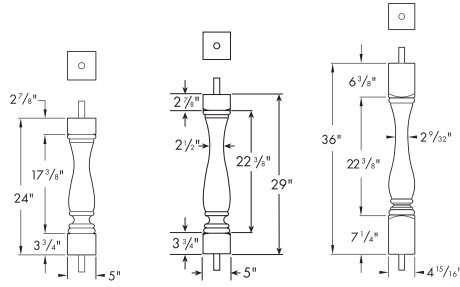

BAL5X24TY

BAL5X29TY

BAL5X36TY

Maximum Center-to-Center
Distance To Meet 4" Rule.
(See Page 2 BL For Details)

6 5/8"

6 7/16"

6 7/32"

7" Balustrade System Baluster - Winnsboro (WB)



Part Number

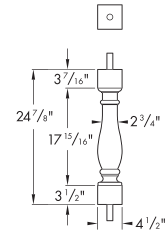

BAL5X25WB

Maximum Center-to-Center
Distance To Meet 4" Rule.
(See Page 2 BL For Details)

6 11/16"

7" Balustrade System Baluster - Woodruff (WF)



Part Number

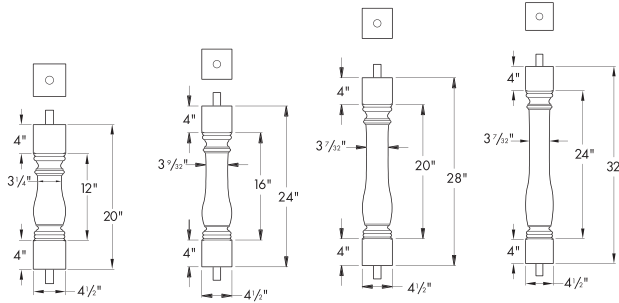

BAL5X20WF

BAL5X24WF

BAL5X28WF

BAL5X32WF

Maximum Center-to-Center
Distance To Meet 4" Rule.
(See Page 2 BL For Details)

7 3/16"

7 1/8"

7 1/8"

7 1/8"

7" Balustrade System Top Rail

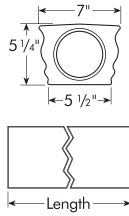

Part Number	Length	Baluster Rail Installation Kit* (See Installation Guide Page 34)
BTR7X96	96"	BRK6-7
BTR7X120	120"	BRK6-7
BTR7X144	144"	BRK6-7

*Connects both ends of one 7" Rail to applications.
May be used for corner or butt connections into NP8X48 or PP8X96.
(2 qty.) 4" wide x 1 1/2" x 2" Angle Brackets.
(8 qty.) #14 x 2 1/2" Stainless Steel Flat Head Screws.

7" Balustrade System Bottom Rail

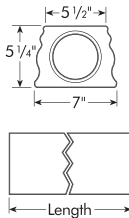

Part Number	Length	Baluster Rail Installation Kit* (See Installation Guide Page 34)	Rail Support Block (See Below)
BBR7X96	96"	BRK6-7	RSB4X4X6
BBR7X120	120"	BRK6-7	RSB4X4X6
BBR7X144	144"	BRK6-7	RSB4X4X6

*Connects both ends of one 7" Rail to applications.
May be used for corner or butt connections into NP8X48 or PP8X96.
(2 qty.) 4" wide x 1 1/2" x 2" Angle Brackets.
(8 qty.) #14 x 2 1/2" Stainless Steel Flat Head Screws.

7" Balustrade System Rail Support Block

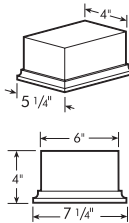

Part Number

RSB4X4X6

Rail Support Blocks should be placed under the Bottom Rail at a span of every 48" or less.
These blocks can be trimmed for height.

7" Balustrade System Baluster Top Rail Radius

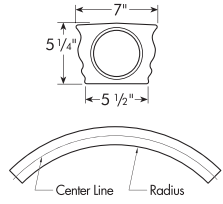

Part Number	Radius	Center Line Length	Baluster Rail Installation Kit* (See Installation Guide Page 34)
BTRR7X24	24"	75" (1/2 Circle)	BRK6-7
BTRR7X43	43"	74" (1/4 Circle)	BRK6-7
BTRR7X58	57 1/2"	96" (1/4 Circle)	BRK6-7
BTRR7X63	63"	99" (1/4 Circle)	BRK6-7
BTRR7X75	74 3/4"	125" (1/4 Circle)	BRK6-7
BTRR7X80	80"	100" (1/5 Circle)	BRK6-7
BTRR7X96	96"	120" (1/5 Circle)	BRK6-7
BTRR7X108	108"	85" (1/8 Circle)	BRK6-7
BTRR7X125	125 1/4"	98" (1/8 Circle)	BRK6-7
BTRR7X126	125 1/2"	98" (1/8 Circle)	BRK6-7
BTRR7X138	138 1/2"	74" (1/12 Circle)	BRK6-7
BTRR7X158	158"	123" (1/8 Circle)	BRK6-7
BTRR7X173	173 1/2"	109" (1/10 Circle)	BRK6-7
BTRR7X210	210"	120" (1/11 Circle)	BRK6-7
BTRR7X271	271"	96" (1/16 Circle)	BRK6-7
BTRR7X297	296 5/8"	147" (1/13 Circle)	BRK6-7
BTRR7X360	360"	96" (1/23 Circle)	BRK6-7

*Connects both ends of one 7" Rail to applications.
 May be used for corner or butt connections into NP8X48 or PP8X96.
 (2 qty.) 4" wide x 1 1/2" x 2" Angle Brackets.
 (8 qty.) #14 x 2 1/2" Stainless Steel Flat Head Screws.

7" Balustrade System Baluster Bottom Rail Radius

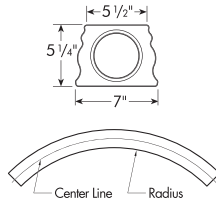





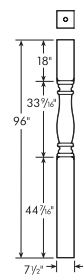

Part Number	Radius	Center Line Length	Baluster Rail Installation Kit* <small>(See Installation Guide Page 34)</small>	Rail Support Block <small>(Page 21 BL)</small>
BBRR7X24	24"	75" (1/2 Circle)	BRK6-7	RSB4X4X6
BBRR7X43	43"	74" (1/4 Circle)	BRK6-7	RSB4X4X6
BBRR7X58	57 1/2"	96" (1/4 Circle)	BRK6-7	RSB4X4X6
BBRR7X63	63"	99" (1/4 Circle)	BRK6-7	RSB4X4X6
BBRR7X75	74 3/4"	125" (1/4 Circle)	BRK6-7	RSB4X4X6
BBRR7X80	80"	100" (1/5 Circle)	BRK6-7	RSB4X4X6
BBRR7X96	96"	120" (1/5 Circle)	BRK6-7	RSB4X4X6
BBRR7X108	108"	85" (1/8 Circle)	BRK6-7	RSB4X4X6
BBRR7X125	125 1/4"	98" (1/8 Circle)	BRK6-7	RSB4X4X6
BBRR7X126	125 1/2"	98" (1/8 Circle)	BRK6-7	RSB4X4X6
BBRR7X138	138 1/2"	74" (1/12 Circle)	BRK6-7	RSB4X4X6
BBRR7X158	158"	123" (1/8 Circle)	BRK6-7	RSB4X4X6
BBRR7X173	173 1/2"	109" (1/10 Circle)	BRK6-7	RSB4X4X6
BBRR7X210	210"	120" (1/11 Circle)	BRK6-7	RSB4X4X6
BBRR7X271	271"	96" (1/16 Circle)	BRK6-7	RSB4X4X6
BBRR7X297	296 5/8"	147" (1/13 Circle)	BRK6-7	RSB4X4X6
BBRR7X360	360"	96" (1/23 Circle)	BRK6-7	RSB4X4X6

*Connects both ends of one 7" Rail to applications.
 May be used for corner or butt connections into NP8X48 or PP8X96.
 (2 qty.) 4" wide x 1 1/2" x 2" Angle Brackets.
 (8 qty.) #14 x 2 1/2" Stainless Steel Flat Head Screws.

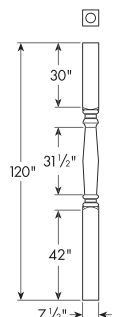
7" Balustrade System Porch Post

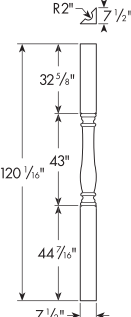
Post is load bearing and reinforced.*

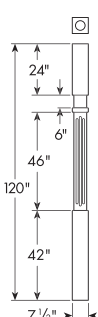
							
Part Number	PP8X96 <i>Note: SCK8 included with this Porch Post.</i>	Part Number	PP8X120A <i>Note: PPK8 included with this Porch Post.</i>	Part Number	PPCV8X120 <i>Note: SCK8 included with this Porch Post.</i>	Part Number	PPF8X120 <i>Note: SCK8 included with this Porch Post.</i>
Porch Post Installation Kit** <i>(See Installation Guide Page 34)</i>	SCK8HDW	Porch Post Installation Kit** <i>(See Installation Guide Page 34)</i>	SCK8HDW	Porch Post Installation Kit** <i>(See Installation Guide Page 34)</i>	SCK8HDW	Porch Post Installation Kit** <i>(See Installation Guide Page 34)</i>	SCK8HDW
Load Rating/Dead Load	12000#	Load Rating/Dead Load	12000#	Load Rating/Dead Load	NONE	Load Rating/Dead Load	12000#

**Porch Post can be field trimmed to various heights without losing load rating.

**Hardware included to secure one Porch Post.







(2 qty.) Galvanized Mounting Brackets.

(4 qty.) #14 x 2" Stainless Steel Sheet Metal Screws.

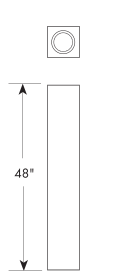
Fasteners to mount angle brackets to floor surface not provided, and Trim Collar must be ordered separate.

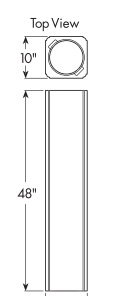
7" Balustrade System Newel Post

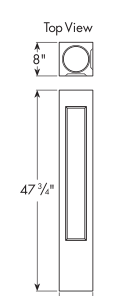
One piece Post reinforced, height trimable.

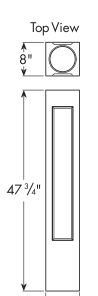
							
Part Number	NP8X48	Part Number	NP10X48	Part Number	NP8X48	Part Number	NPSP8X48
Newel Post Installation Kit** <i>(See Installation Guide Page 34)</i>	NPK8	Newel Post Installation Kit** <i>(See Installation Guide Page 34)</i>	NPK10	Newel Post Installation Kit** <i>(See Installation Guide Page 34)</i>	NPK8	Newel Post Installation Kit** <i>(See Installation Guide Page 34)</i>	NPK8

*NPK8 kit includes hardware to secure one Newel Post and is purchased separately:

(2 qty.) 3/8" - 16 Hex Nuts.

(2 qty.) 3/8" - Lock Washers.

(2 qty.) 3/8" - Flat Washers.

(1 qty.) 1/4" x 6 1/2" Diameter Steel Top Mounting Plate.

(2 qty.) 3/8" x 50" Threaded Rods.

(1 qty.) 1/4" x 3 1/2" x 3 1/2" Octagon Steel Base Plate.

Fasteners to mount Steel Base Plate to floor surface not provided.

*NPK10 kit includes hardware to secure one Newel Post and is purchased separately:

(1 qty.) Steel Base Plate.











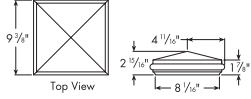

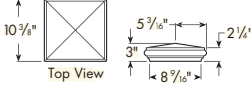

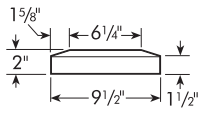
(1 qty.) Channel Bracket.

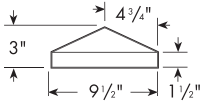
(1 qty.) 1/2" - 13 Hex Nut.

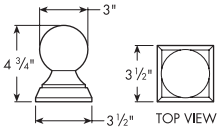
(1 qty.) 1/2" Lock Washer.

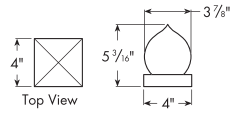
(1 qty.) 13" x 72" Threaded Rod.

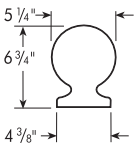
7" Balustrade System
Newel Post Accessories

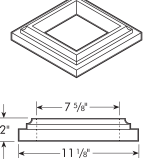
		Part Number	Coordinating Newel Post Accessories
		PST8X8FP Fancy Peak	—
		PST9X9FP Fancy Peak	—
		PST10X10F Post Top - Flat	B5X7 PST3X5 PST4X5
		PST10X10P Post Top - Peaked	—
		PST3X5 Post Top - Ball	PST10X10F
		PST4X5 Post Top - Ball	PST10X10F
		B5X7 Ball	PST10X10F
		TC8 Base Trim Collar	—

12" BALUSTRADE SYSTEM

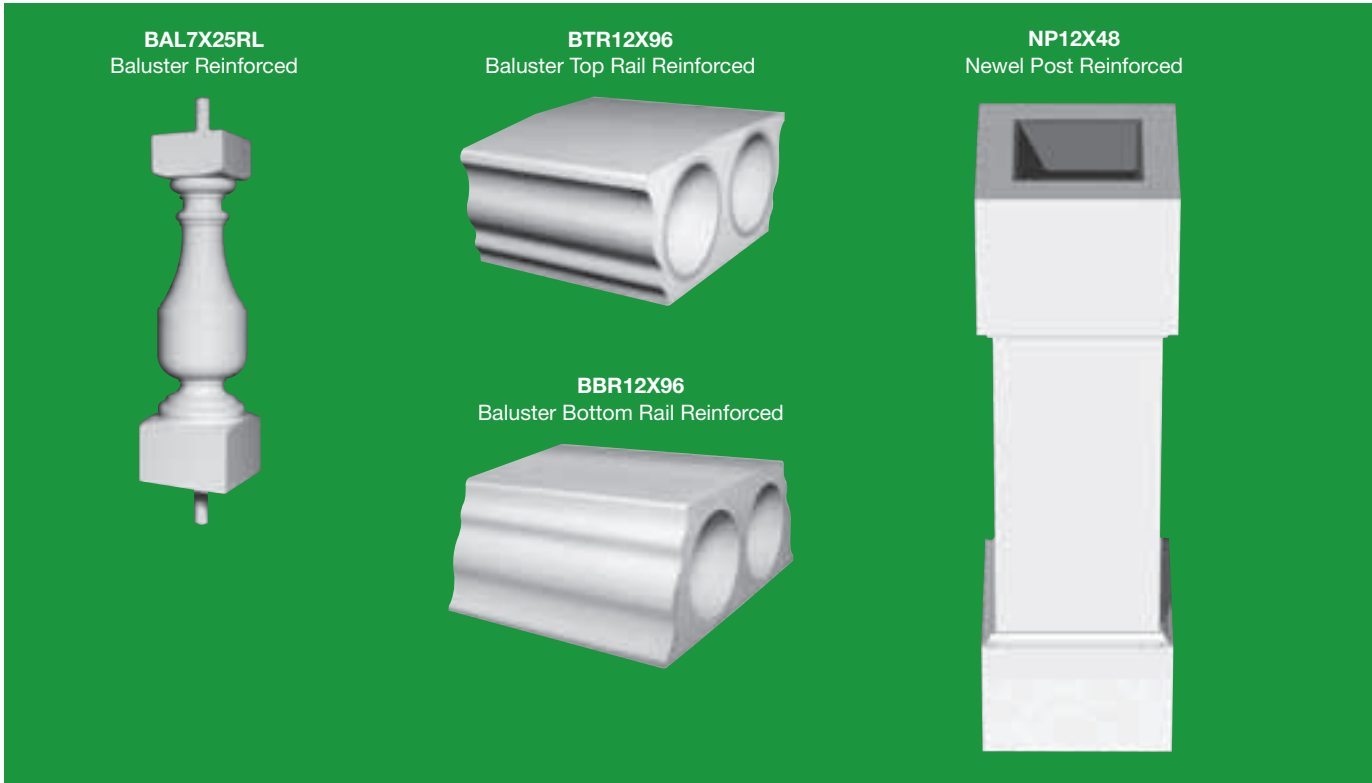
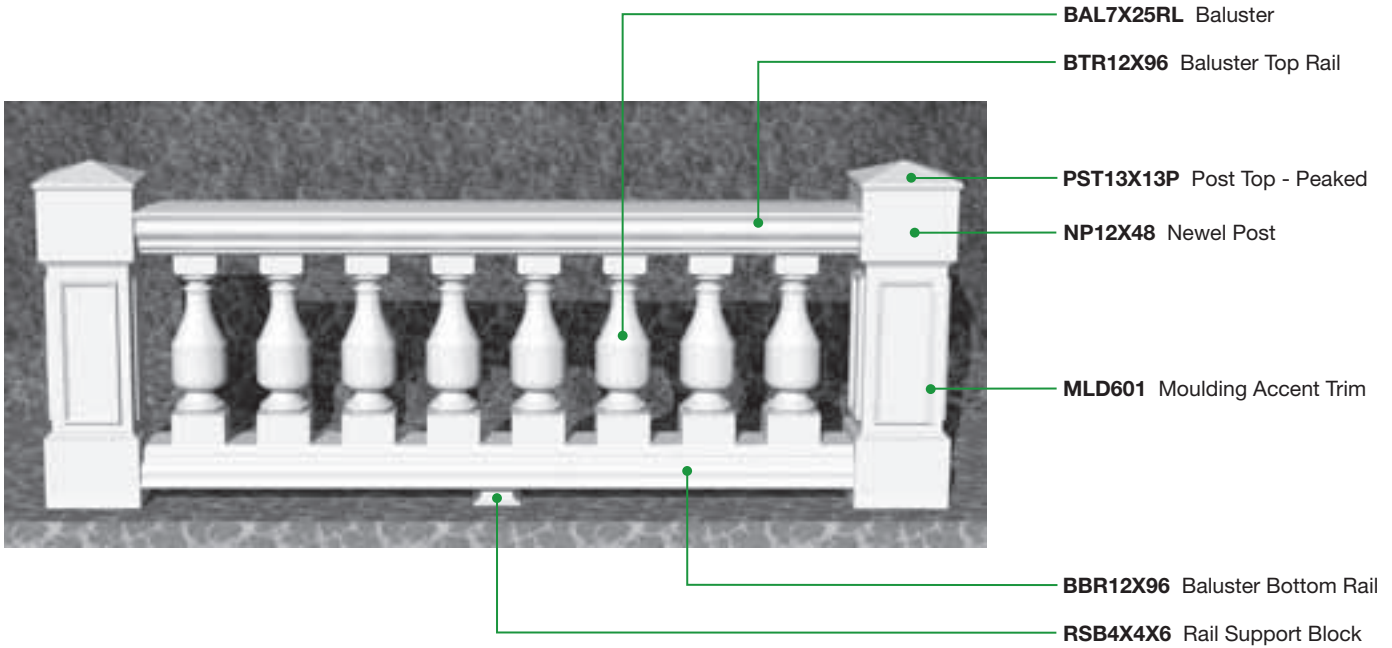

12" Balustrade System Baluster - Ashley (AY)

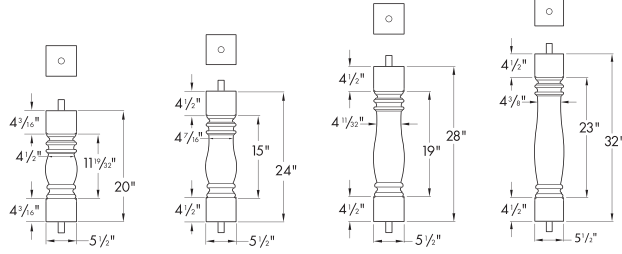

Part Number

BAL6X20AY

BAL6X24AY

BAL6X28AY

BAL6X32AY

Maximum Center-to-Center
Distance To Meet 4" Rule.
(See Page 2 BL For Details)

8 13/16"

8 3/8"

8 5/16"

8 5/16"

12" Balustrade System Baluster - Baroque (BR)

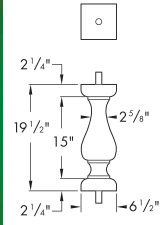

Part Number

BAL7X20BR*

Maximum Center-to-Center
Distance To Meet 4" Rule.
(See Page 2 BL For Details)

6 9/16"

*Cannot be used for stair applications.

12" Balustrade System Baluster - Beaumont (BE)

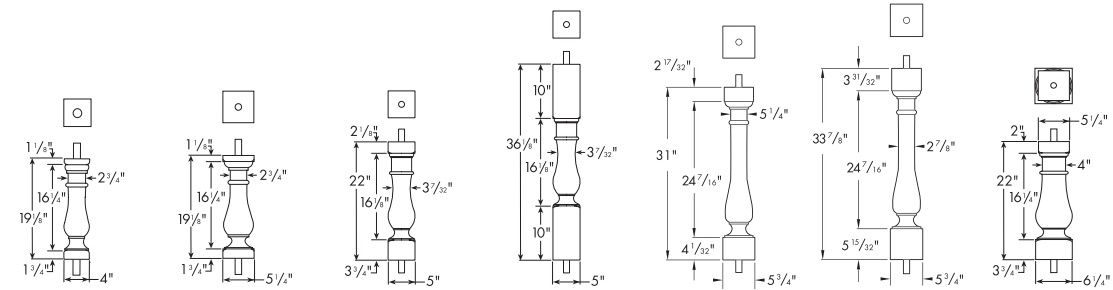

Part Number

BAL4X19BE*

BAL5X19BE*

BAL5X22BE

BAL5X22BETB

BAL5X31BE*

BAL5X34BE

BAL6X22BE

Maximum Center-to-Center
Distance To Meet 4" Rule.
(See Page 2 BL For Details)

6 1/4"

6 9/16"

7 1/8"

7 1/8"

6 27/32"

6 7/8"

7 15/16"

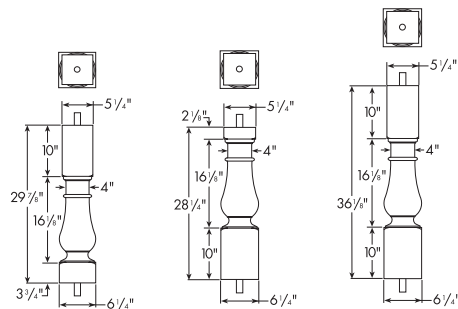

Part Number

BAL6X22BET

BAL6X22BEB

BAL6X22BETB

Maximum Center-to-Center
Distance To Meet 4" Rule.
(See Page 2 BL For Details)

7 15/16"

7 15/16"

7 1/4"

*Cannot be used for stair applications.

12" Balustrade System Baluster - Classic (CC)



Part Number

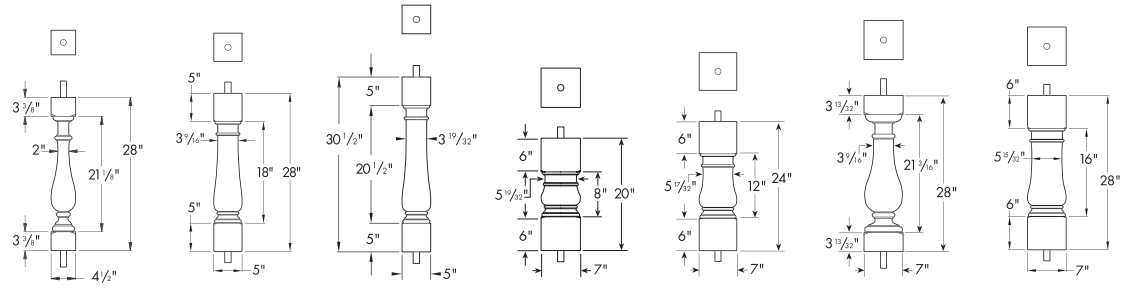

BAL5X28CCOB **BAL5X28CC** **BAL5X30CC** **BAL7X20CC** **BAL7X24CC** **BAL7X28CCOB*** **BAL7X28CC**

Maximum Center-to-Center Distance To Meet 4" Rule. (See Page 2 BL For Details)

7 1/2" 7 1/2" 7 1/2" 9 13/16" 9 7/16" 7 1/2" 9 3/8"

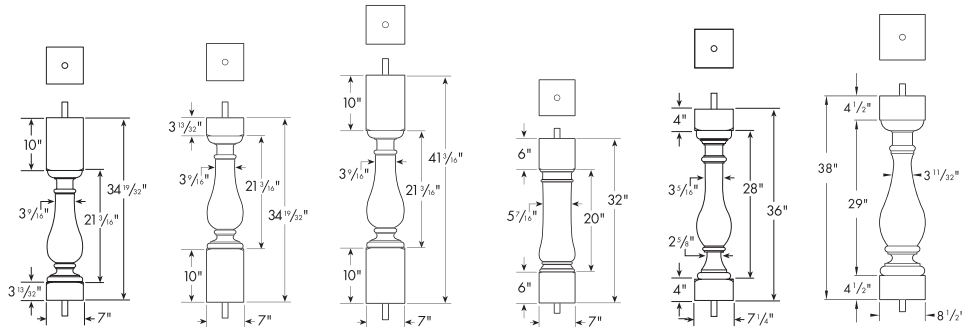

Part Number

BAL7X28CCTOB* **BAL7X28CCBOB** **BAL7X28CCTBOB** **BAL7X32CC** **BAL7X36CC** **BAL9X38CC***

Maximum Center-to-Center Distance To Meet 4" Rule. (See Page 2 BL For Details)

7 1/2" 7 1/2" 7 1/2" 9 3/8" 7 1/4" 8 1/2"

*Cannot be used for stair applications.

12" Balustrade System Baluster - Claremont (CL)



Part Number

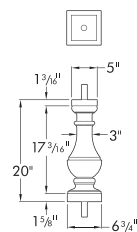

BAL6X20CL*

Maximum Center-to-Center Distance To Meet 4" Rule. (See Page 2 BL For Details)

6 15/16"

*Cannot be used for stair applications.

12" Balustrade System Baluster - Jillian (JI)



Part Number

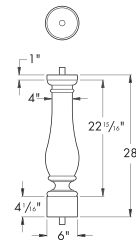

BAL6X28JI*

Maximum Center-to-Center Distance To Meet 4" Rule. (See Page 2 BL For Details)

7 15/16"

*Cannot be used for stair applications.

12" Balustrade System Baluster - Logan (LN)

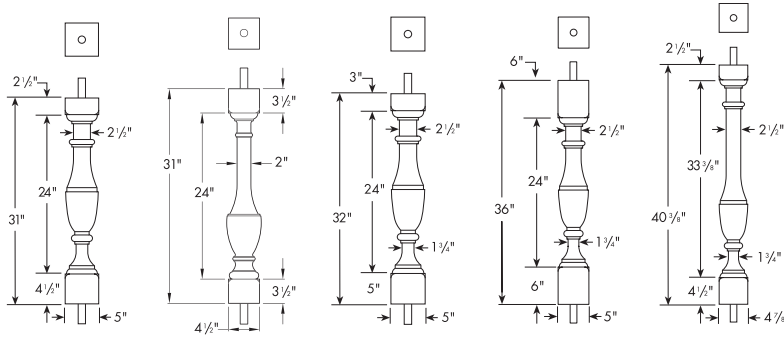

Part Number	BAL5X31LN0B*	BAL5X31LN	BAL5X32LN	BAL5X36LN	BAL5X40LN
Maximum Center-to-Center Distance To Meet 4" Rule. (See Page 2 BL For Details)	5 9/16"	5 15/16"	5 11/16"	5 11/16"	5 11/16"

*Cannot be used for stair applications.

12" Balustrade System Baluster - Nouveau (NV)

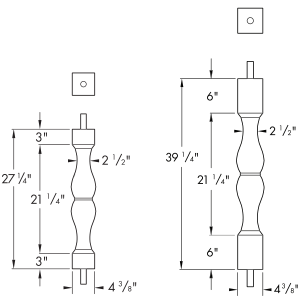

Part Number	BAL4X27NV	BAL4X33NV
Maximum Center-to-Center Distance To Meet 4" Rule. (See Page 2 BL For Details)	6 15/32"	6 7/16"

12" Balustrade System Baluster - Rosedale (RL)



Part Number

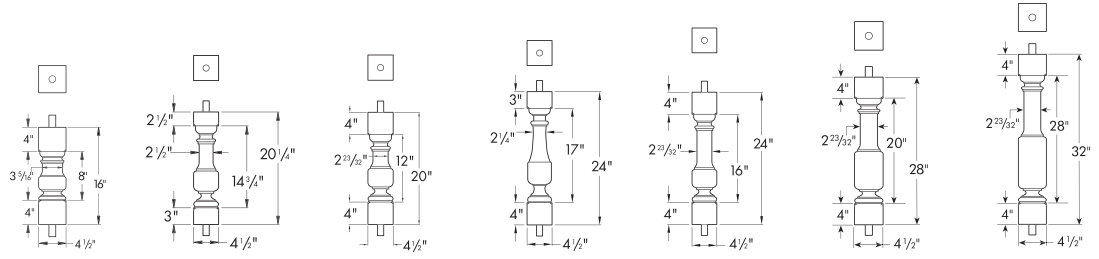

BAL5X16RL BAL5X20RLOB BAL5X20RL BAL5X24RLOB BAL5X24RL BAL5X28RL BAL5X32RL

Maximum Center-to-Center
Distance To Meet 4" Rule.
(See Page 2 BL For Details)

7 1/4" 6 7/16" 6 5/8" 6 3/16" 6 5/8" 6 5/8" 6 5/8"

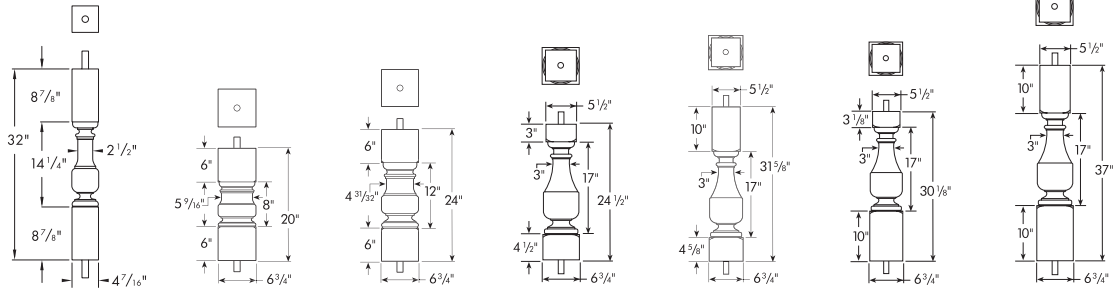

Part Number

BAL5X32RLTB BAL7X20RL BAL7X24RL BAL7X25RL BAL7X25RLT BAL7X25RLB BAL7X25RLTB

Maximum Center-to-Center
Distance To Meet 4" Rule.
(See Page 2 BL For Details)

6 7/16" 9 1/2" 8 7/8" 6 15/16" 6 15/16" 6 15/16" 6 15/16"

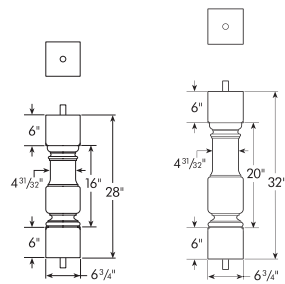

Part Number

BAL7X28RL BAL7X32RL

Maximum Center-to-Center
Distance To Meet 4" Rule.
(See Page 2 BL For Details)

8 7/8" 8 7/8"

12" Balustrade System Baluster - Trinity (TY)

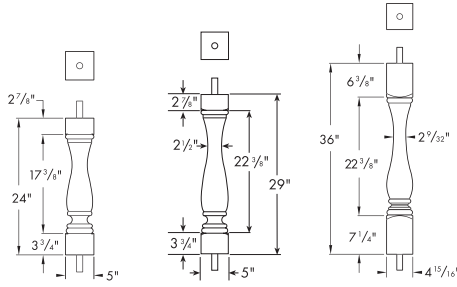

Part Number

BAL5X24TY

BAL5X29TY

BAL5X36TY

Maximum Center-to-Center
Distance To Meet 4" Rule.
(See Page 2 BL For Details)

6 5/8"

6 7/16"

6 7/32"

12" Balustrade System Baluster - Riley (RY)

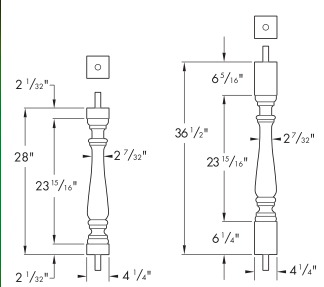

Part Number

BAL4X28RY

BAL4X37RY

Maximum Center-to-Center
Distance To Meet 4" Rule.
(See Page 2 BL For Details)

6 5/32"

6 5/32"

*Cannot be used for stair applications.

12" Balustrade System Baluster - Square (SQ)

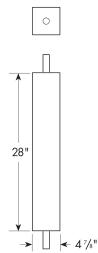

Part Number

BAL5X28SQ

Maximum Center-to-Center
Distance To Meet 4" Rule.
(See Page 2 BL For Details)

8 13/16"

12" Balustrade System Baluster - Winnsboro (WB)

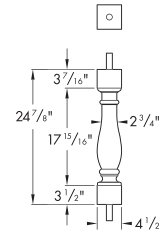

Part Number

BAL5X25WB

Maximum Center-to-Center
Distance To Meet 4" Rule.
(See Page 2 BL For Details)

6 11/16"