

6" BALUSTRADE SYSTEM

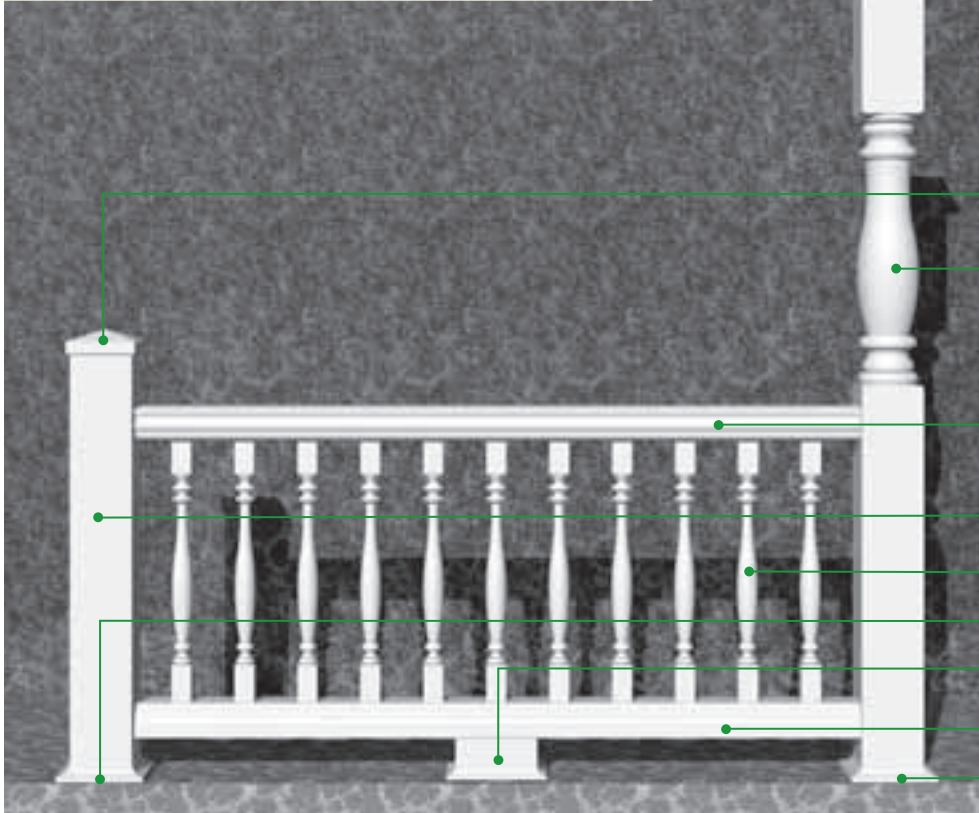

TC8 Trim Collar

PST10X10P Post Top - Peaked

PP8X96 Porch Post
(Installation Kit Included)

BTR6X96 Baluster Top Rail

NP8X48 Newel Post

BAL3X32AY Baluster

TC8 Trim Collar

RSB4X4X6 Rail Support Block

BBR6X96 Baluster Bottom Rail

TC8 Trim Collar

BAL3X32AY
Baluster Reinforced



BTR6X96
Baluster Top Rail Reinforced



BBR6X96
Baluster Bottom Rail Reinforced

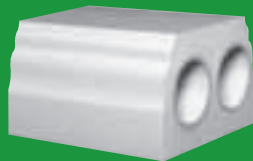

NP8X48
Newel Post Reinforced



PP8X96
Load-bearing Porch Post Reinforced



6" Balustrade System Baluster - Ashley (AY)

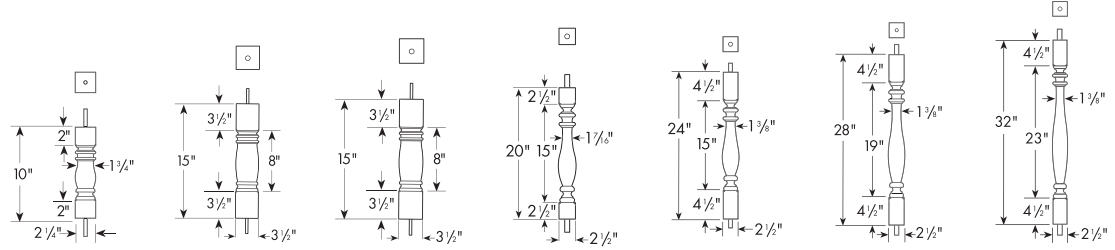

Part Number

BAL2X10AY

BAL2.5X15AY

BAL3X15AY

BAL3X20AY

BAL3X24AY

BAL3X28AY

BAL3X32AY

Maximum Center-to-Center
Distance To Meet 4" Rule.
(See Page 2 BL For Details)

5 7/8"

5 13/16"

7 1/16"

5 3/8"

5 7/16"

5 3/8"

5 3/8"

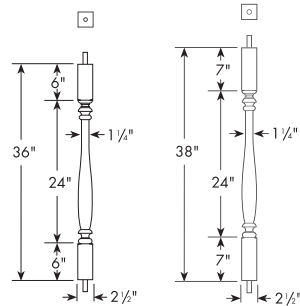

Part Number

BAL3X36AY

BAL3X38AY

Maximum Center-to-Center
Distance To Meet 4" Rule.
(See Page 2 BL For Details)

5 3/16"

5 3/16"

**Ideal for Porch Spandrel application.*

6" Balustrade System Baluster - Classic (CC)

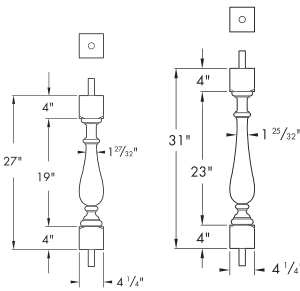

Part Number

BAL4X27CCOB

BAL4X31CCOB

Maximum Center-to-Center
Distance To Meet 4" Rule.
(See Page 2 BL For Details)

5 13/16"

5 11/16"

6" Balustrade System Baluster - Charlotte (CH)

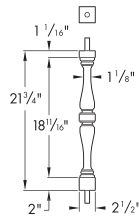

Part Number

BAL3X22CH*

Maximum Center-to-Center
Distance To Meet 4" Rule.
(See Page 2 BL For Details)

5 1/16"

**Cannot be used for stair applications.*

6" Balustrade System
Baluster - Fischer (FI)

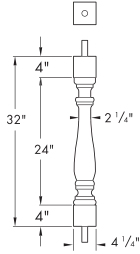

Part Number **BAL4X32FI**

Maximum Center-to-Center Distance To Meet 4" Rule. (See Page 2 BL For Details)

6 3/16"

6" Balustrade System
Baluster - Florence (FL)

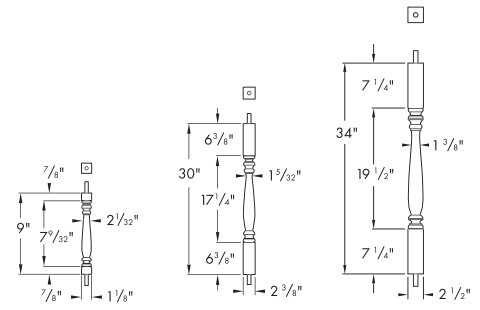

Part Number

BAL1X9FL

BAL3X30FL

BAL3X34FL

Maximum Center-to-Center Distance To Meet 4" Rule. (See Page 2 BL For Details)

4 21/32"

5 5/32"

5 7/32"

6" Balustrade System
Baluster - Logan (LN)

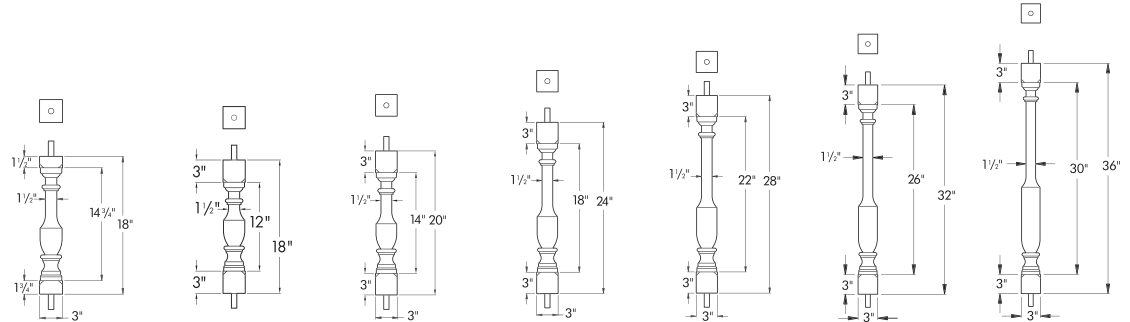

Part Number

BAL3X18LN0B*

BAL3X18LN

BAL3X20LN

BAL3X24LN

BAL3X28LN

BAL3X32LN

BAL3X36LN

Maximum Center-to-Center Distance To Meet 4" Rule. (See Page 2 BL For Details)

5 7/16"

5 7/16"

5 7/16"

5 7/16"

5 7/16"

5 7/16"

5 3/16"

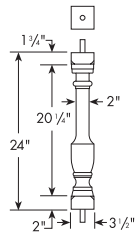

Part Number

BAL4X24LN*

Maximum Center-to-Center Distance To Meet 4" Rule. (See Page 2 BL For Details)

5 15/16"

*Cannot be used for stair applications.

6" Balustrade System Baluster - Marie (ME)

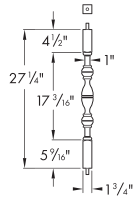

Part Number **BAL2X27ME**

Maximum Center-to-Center
Distance To Meet 4" Rule.
(See Page 2 BL For Details)

4 15/16"

6" Balustrade System Baluster - Piedmont (PM)

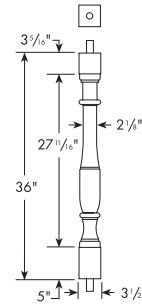

Part Number **BAL4X36PM**

Maximum Center-to-Center
Distance To Meet 4" Rule.
(See Page 2 BL For Details)

5 7/8"

6" Balustrade System Baluster - Riley (RY)

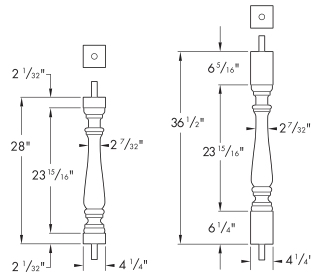

Part Number **BAL4X28RY***

BAL4X37RY

Maximum Center-to-Center
Distance To Meet 4" Rule.
(See Page 2 BL For Details)

6 5/32"

6 5/32"

*Cannot be used for stair applications.

6" Balustrade System Baluster - Woodruff (WF)

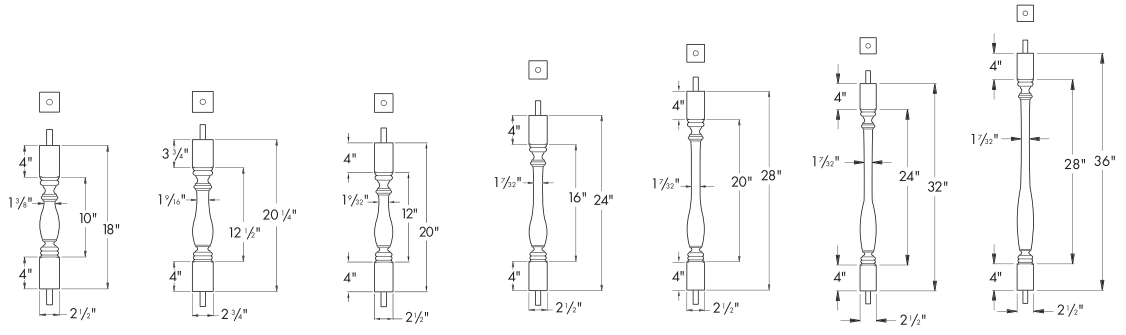

Part Number	BAL3X18WF	BAL3X20WFOB	BAL3X20WF	BAL3X24WF	BAL3X28WF	BAL3X32WF	BAL3X36WF
Maximum Center-to-Center Distance To Meet 4" Rule. (See Page 2 BL For Details)	5 1/2"	5 1/2"	5 5/8"	5 1/8"	5 1/8"	5 1/8"	5 1/8"

6" Balustrade System Top Rail

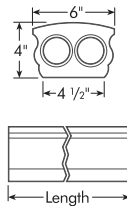

Part Number	Length	Baluster Rail Installation Kit* (See Installation Guide Page 33)
BTR6X96	96"	BRK6-7
BTR6X144 <i>Note: Max. rail span distance for field applications is 96"</i>	144"	BRK6-7

*Connects both ends of one 6" Rail to applications.
May be used for corner or butt connections into NP8X48 or PP8X96.
(2 qty.) 4" wide x 1 1/2" x 2" Angle Brackets.
(8 qty.) #14 x 2 1/2" Stainless Steel Flat Head Screws.

6" Balustrade System Bottom Rail

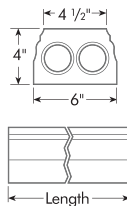

Part Number	Length	Baluster Rail Installation Kit* (See Installation Guide Page 33)	Rail Support Block (See Below)
BBR6X96	96"	BRK6-7	RSB4X4X6
BBR6X144 <i>Note: Max. rail span distance for field applications is 96"</i>	144"	BRK6-7	RSB4X4X6

*Connects both ends of one 6" Rail to applications.
May be used for corner or butt connections into NP8X48 or PP8X96.
(2 qty.) 4" wide x 1 1/2" x 2" Angle Brackets.
(8 qty.) #14 x 2 1/2" Stainless Steel Flat Head Screws.

6" Balustrade System Rail Support Block

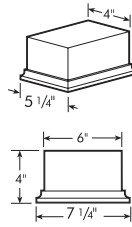

Part Number

RSB4X4X6

Rail Support Blocks should be placed under the Bottom Rail at a span of every 48" or less. These blocks can be trimmed for height.

6" Balustrade System Baluster Top Rail Radius

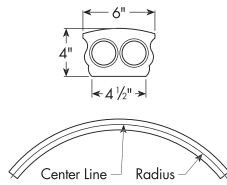

Part Number

BTRR6X75

Radius

75"

Center Line Length

134" (1/4 Circle)

Baluster Rail Installation Kit*
(See Installation Guide Page 32)

BRK6-7

**Connects both ends of one 6" Rail to applications. May be used for corner or butt connections into NP8X48 or PP8X96. (2 qty.) 4" wide x 1 1/2" x 2" Angle Brackets. (8 qty.) #14 x 2 1/2" Stainless Steel Flat Head Screws.*

6" Balustrade System Baluster Bottom Rail Radius

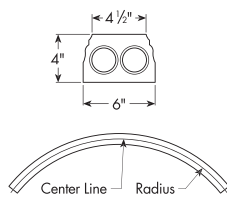

Part Number

BBRR6X75

Radius

75"

Center Line Length

134" (1/4 Circle)

Baluster Rail Installation Kit*
(See Installation Guide Page 32)

BRK6-7

Rail Support Block
(Page 7 BL)







RSB4X4X6

**Connects both ends of one 6" Rail to applications. May be used for corner or butt connections into NP8X48 or PP8X96. (2 qty.) 4" wide x 1 1/2" x 2" Angle Brackets. (8 qty.) #14 x 2 1/2" Stainless Steel Flat Head Screws.*

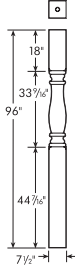
6" Balustrade System

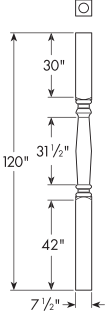
Porch Post

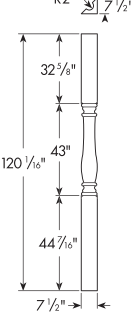
Post is load bearing and reinforced.*

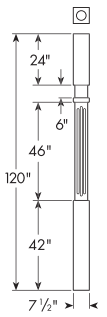
							
Part Number	PP8X96 <i>Note: SCK8 included with this Porch Post.</i>	Part Number	PP8X120A <i>Note: PPK8 included with this Porch Post.</i>	Part Number	PPCV8X120 <i>Note: SCK8 included with this Porch Post.</i>	Part Number	PPF8X120 <i>Note: SCK8 included with this Porch Post.</i>
Porch Post Installation Kit** <i>(See Installation Guide Page 34)</i>	SCK8HDW	Porch Post Installation Kit** <i>(See Installation Guide Page 34)</i>	SCK8HDW	Porch Post Installation Kit** <i>(See Installation Guide Page 34)</i>	SCK8HDW	Porch Post Installation Kit** <i>(See Installation Guide Page 34)</i>	SCK8HDW
Load Rating/Dead Load	12000#	Load Rating/Dead Load	12000#	Load Rating/Dead Load	NONE	Load Rating/Dead Load	12000#

**Porch Post can be field trimmed to various heights without losing load rating.

**Hardware included to secure one Porch Post.

(2 qty.) Galvanized Mounting Brackets.







(4 qty.) #14 x 2" Stainless Steel Sheet Metal Screws.

Fasteners to mount angle brackets to floor surface not provided, and Trim Collar must be ordered separate.

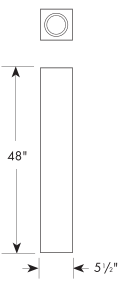
6" Balustrade System

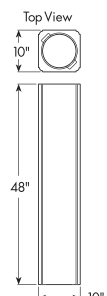
Newel Post

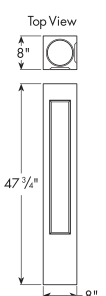
One piece Post reinforced, height trimable.

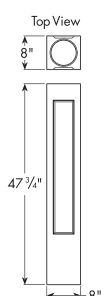
							
Part Number	NP8X48	Part Number	NP10X48	Part Number	NPCP8X48	Part Number	NPSP8X48
Newel Post Installation Kit** <i>(See Installation Guide Page 34)</i>	NPK8	Newel Post Installation Kit** <i>(See Installation Guide Page 34)</i>	NPK10	Newel Post Installation Kit** <i>(See Installation Guide Page 34)</i>	NPK8	Newel Post Installation Kit** <i>(See Installation Guide Page 34)</i>	NPK8

*NPK8 kit includes hardware to secure one Newel Post and is purchased separately:

(2 qty.) 3/8" - 16 Hex Nuts.

(2 qty.) 3/8" - Lock Washers.

(2 qty.) 3/8" - Flat Washers.

(1 qty.) 1/4" x 6 1/2" Diameter Steel Top Mounting Plate.

(2 qty.) 3/8" x 50" Threaded Rods.

(1 qty.) 1/4" x 3 1/2" x 3 1/2" Octagon Steel Base Plate.

Fasteners to mount Steel Base Plate to floor surface not provided.

*NPK10 kit includes hardware to secure one Newel Post and is purchased separately:

(1 qty.) Steel Base Plate.











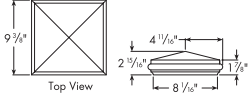

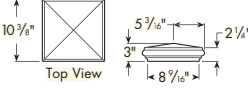

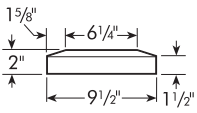
(1 qty.) Channel Bracket.

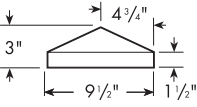
(1 qty.) 1/2" - 13 Hex Nut.

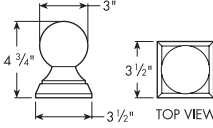
(1 qty.) 1/2" Lock Washer.

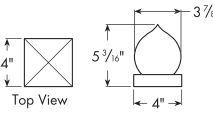
(1 qty.) 13" x 72" Threaded Rod.

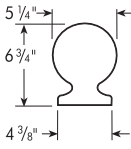
6" Balustrade System Newel Post Accessories

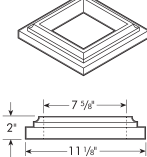
		Part Number	Coordinating Newel Post Accessories	
		PST8X8FP Fancy Peak	—	
		PST9X9FP Fancy Peak	—	
		PST10X10F Post Top - Flat	B5X7 PST3X5 PST4X5	
		PST10X10P Post Top - Peaked	—	
		PST3X5 Post Top - Ball	PST10X10F	
		PST4X5 Post Top - Ball	PST10X10F	
		B5X7 Ball	PST10X10F	
		TC8 Base Trim Collar	—	

7" BALUSTRADE SYSTEM

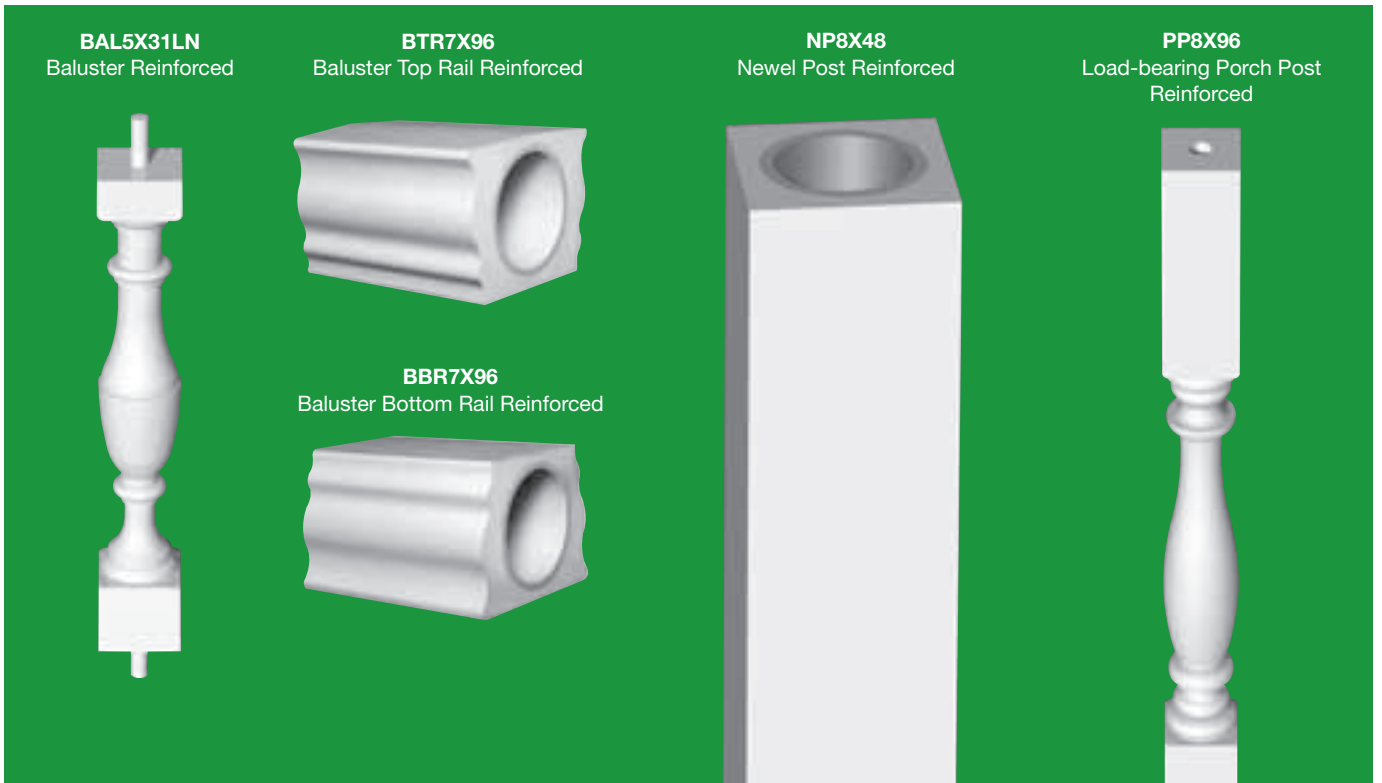
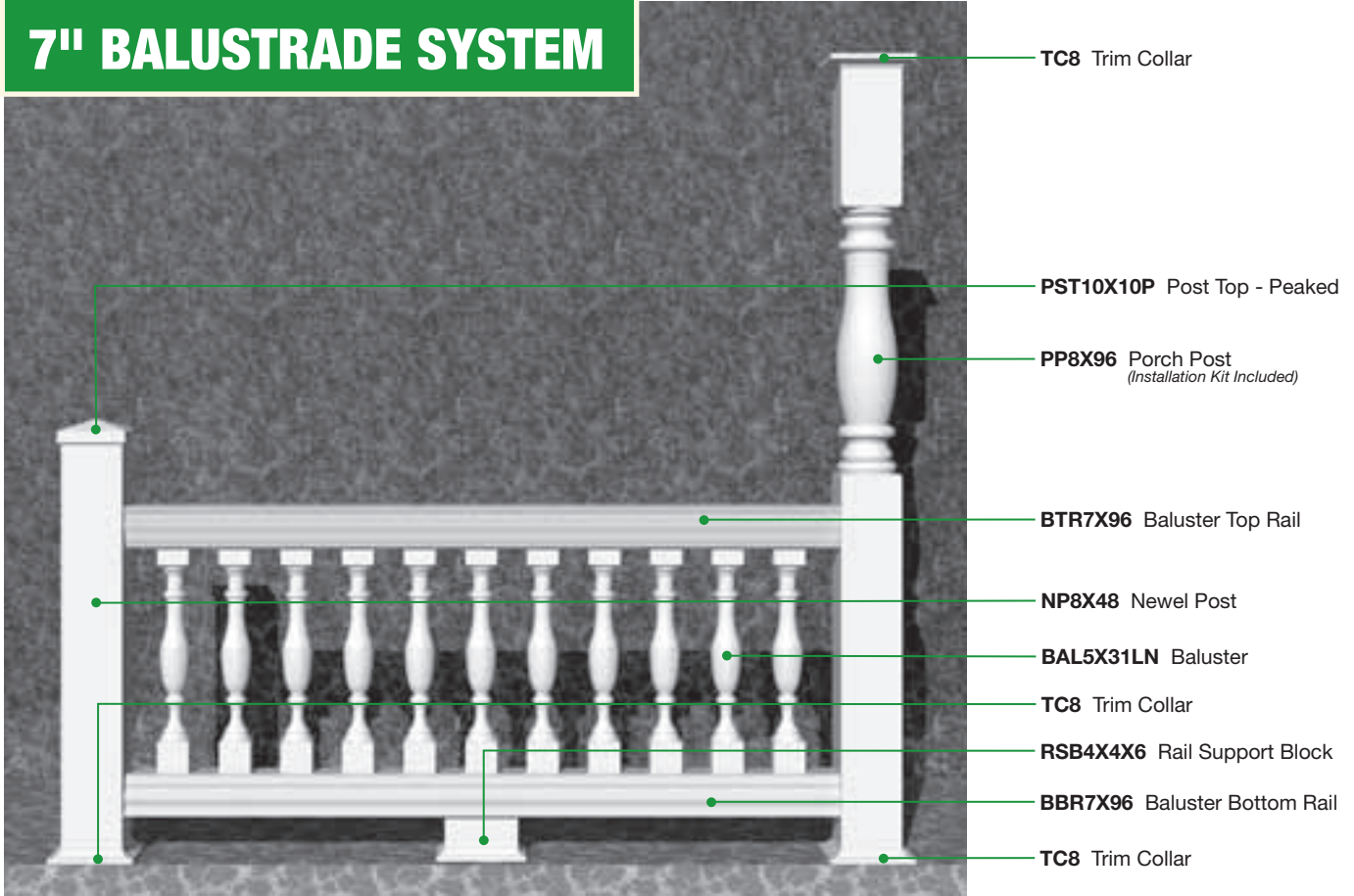

7" Balustrade System Baluster - Ashley (AY)

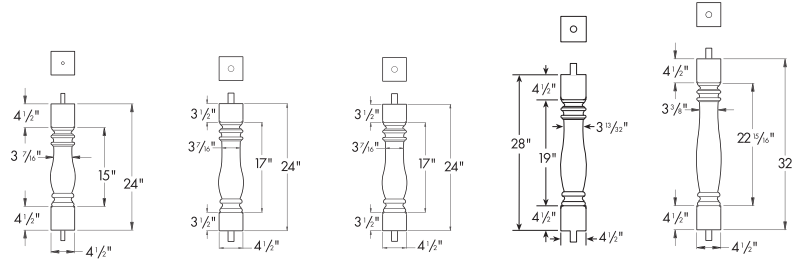

Part Number

BAL4X24AY

BAL5X20AY

BAL5X24AY

BAL5X28AY

BAL5X32AY

Maximum Center-to-Center
Distance To Meet 4" Rule.
(See Page 2 BL For Details)

7 3/8"

7 5/8"

7 3/8"

7 5/16"

7 5/16"

7" Balustrade System Baluster - Classic (CC)

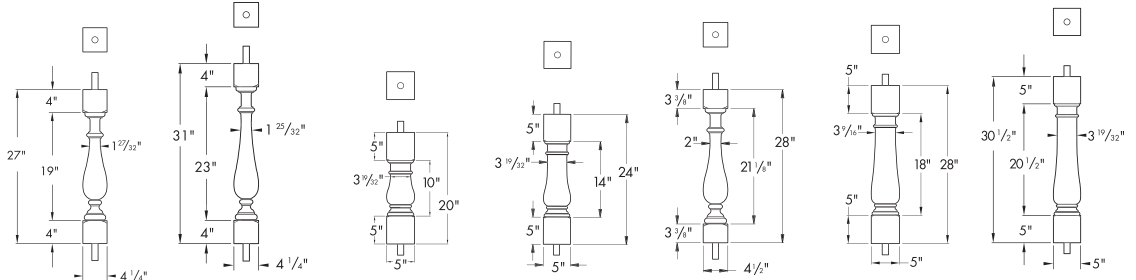

Part Number

BAL4X27CCOB

BAL4X31CCOB

BAL5X20CC

BAL5X24CC

BAL5X28CCOB*

BAL5X28CC

BAL5X30CC

Maximum Center-to-Center
Distance To Meet 4" Rule.
(See Page 2 BL For Details)

5 13/16"

5 11/16"

7 5/8"

7 5/8"

5 7/8"

7 1/2"

7 1/2"

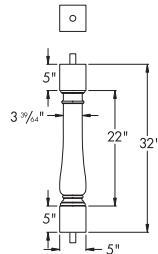

Part Number

BAL5X32CC

Maximum Center-to-Center
Distance To Meet 4" Rule.
(See Page 2 BL For Details)

7 1/2"

*Cannot be used for stair applications.

7" Balustrade System
Baluster - Fischer (FI)

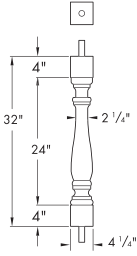

Part Number **BAL4X32FI**

Maximum Center-to-Center Distance To Meet 4" Rule. (See Page 2 BL For Details)

6 3/16"

7" Balustrade System
Baluster - Beaumont (BE)

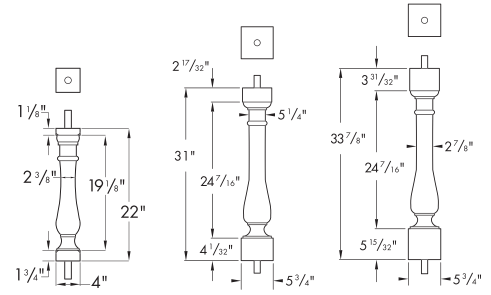

Part Number **BAL4X22BE***

Part Number **BAL5X31BE***

Part Number **BAL5X34BE**

Maximum Center-to-Center Distance To Meet 4" Rule. (See Page 2 BL For Details)

6 5/16"

6 27/32"

6 7/8"

*Cannot be used for stair applications.

7" Balustrade System
Baluster - Jillian (JI)

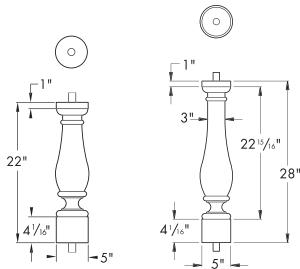

Part Number

BAL5X22JI*

BAL5X28JI*

Maximum Center-to-Center Distance To Meet 4" Rule. (See Page 2 BL For Details)

7"

6 15/16"

*Cannot be used for stair applications.

7" Balustrade System Baluster - Logan (LN)



Part Number

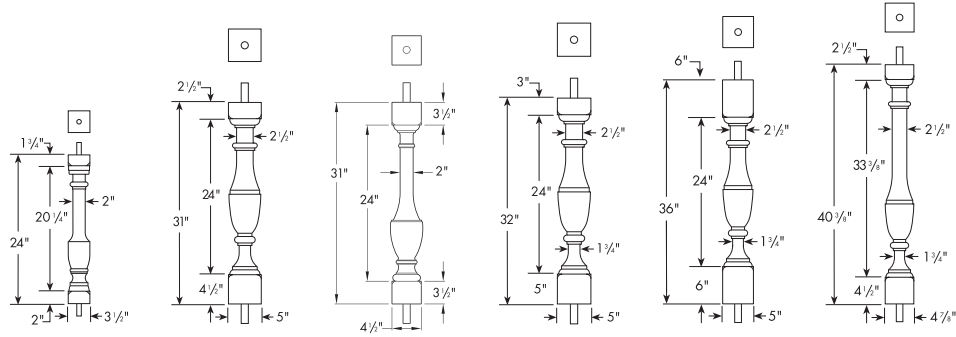

BAL4X24LN*

BAL5X31LN0B*

BAL5X31LN

BAL5X32LN

BAL5X36LN

BAL5X40LN

Maximum Center-to-Center
Distance To Meet 4" Rule.
(See Page 2 BL For Details)

5 15/16"

5 11/16"

5 15/16"

5 11/16"

5 11/16"

5 11/16"

*Cannot be used for stair applications.

7" Balustrade System Baluster - Nouveau (NV)



Part Number

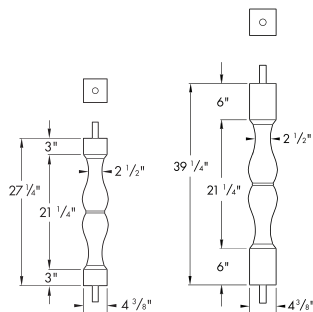

BAL4X27NV

BAL4X33NV

Maximum Center-to-Center
Distance To Meet 4" Rule.
(See Page 2 BL For Details)

6 15/32"

6 7/16"

7" Balustrade System Baluster - Piedmont (PM)



Part Number

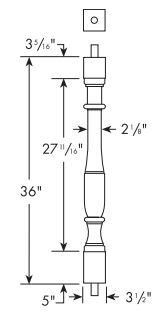

BAL4X36PM

Maximum Center-to-Center
Distance To Meet 4" Rule.
(See Page 2 BL For Details)

5 7/8"

7" Balustrade System
Baluster - Riley (RY)

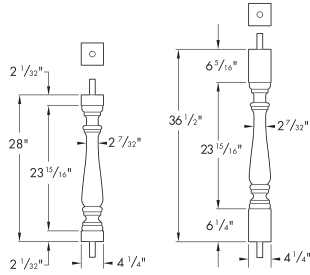

Part Number

BAL4X28RY*

BAL4X37RY

Maximum Center-to-Center Distance To Meet 4" Rule. (See Page 2 BL For Details)

6 5/32"

6 5/32"

*Cannot be used for stair applications.

7" Balustrade System
Baluster - Square (SQ)

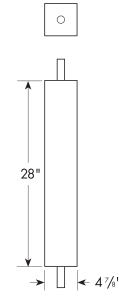

Part Number

BAL5X28SQ

Maximum Center-to-Center Distance To Meet 4" Rule. (See Page 2 BL For Details)

8 13/16"

7" Balustrade System
Baluster - Rosedale (RL)

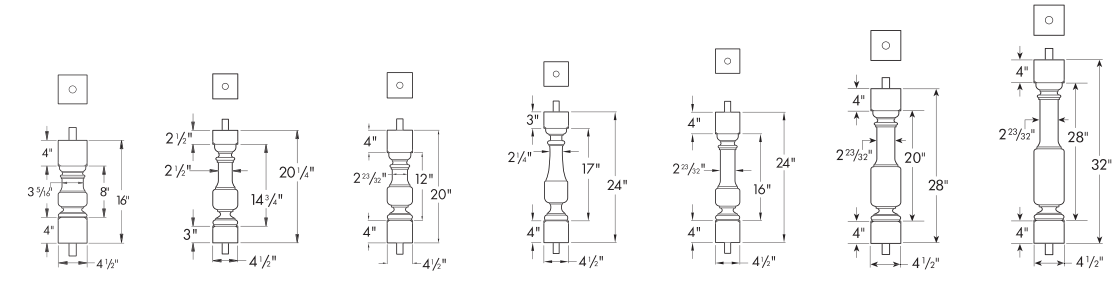

Part Number

BAL5X16RL

BAL5X20RLOB*

BAL5X20RL

BAL5X24RLOB*

BAL5X24RL

BAL5X28RL

BAL5X32RL

Maximum Center-to-Center Distance To Meet 4" Rule. (See Page 2 BL For Details)

7 1/4"

6 7/16"

6 5/8"

6 3/16"

6 5/8"

6 5/8"

6 5/8"

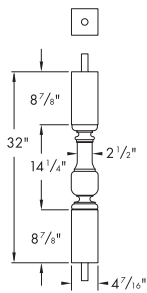

Part Number

BAL5X32RLTB

Maximum Center-to-Center Distance To Meet 4" Rule. (See Page 2 BL For Details)

6 7/16"

*Cannot be used for stair applications.