

# BALUSTRADE SYSTEMS

At Classic Heritage, we are committed to preserving the traditional architectural lines and design by adapting them to the evolving materials of today. By using molded limestone we have captured the look and feel of limestone while substantially reducing the weight and price.

We offer the building industry high quality products specially engineered to exceed existing standards.



## RAILS



## NEWEL POSTS



## BALUSTER



RAILS  
Top and bottom

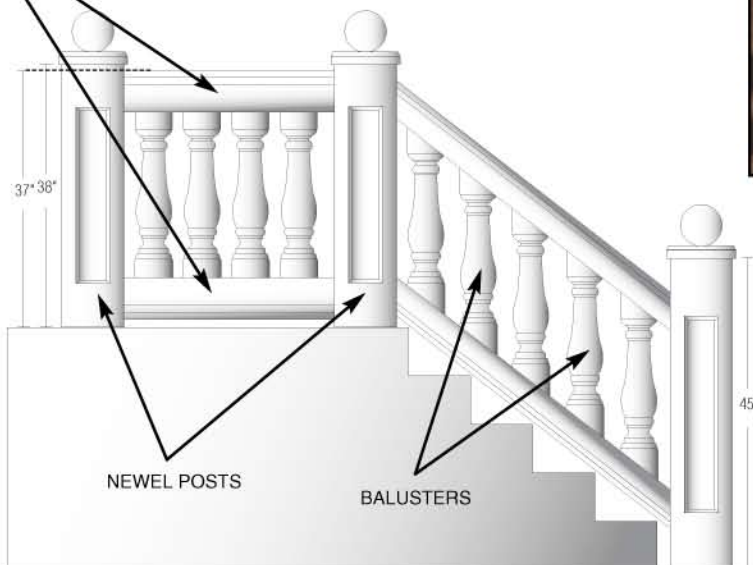

- Look and feel of limestone at a fraction of the cost
- Lightweight-suitable for today's frame construction
- Designed to withstand extreme weather conditions
- Curved railings and other custom installations available

# RAILS & NEWEL POSTS

## SMALL RAILS

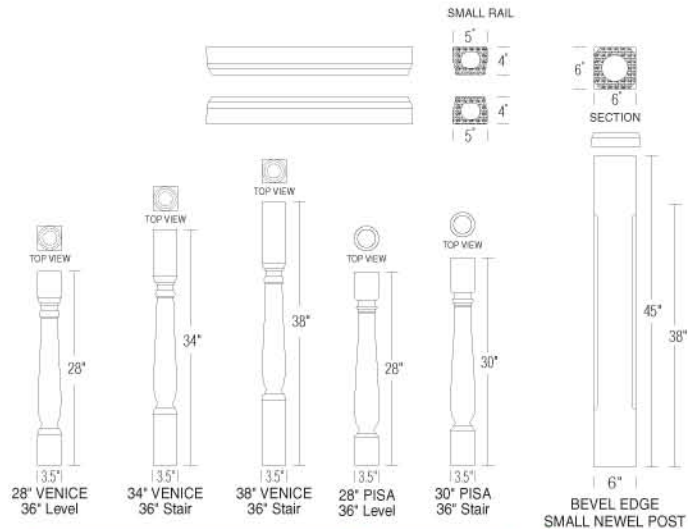

VENICE

PISA

NEWEL POST

CHOOSE FROM MANY CLASSIC ARCHITECTURAL DESIGNS – OR WE CAN BUILD CUSTOM SIZES AND SHAPES FROM YOUR SPECIFICATIONS

## MEDIUM RAILS

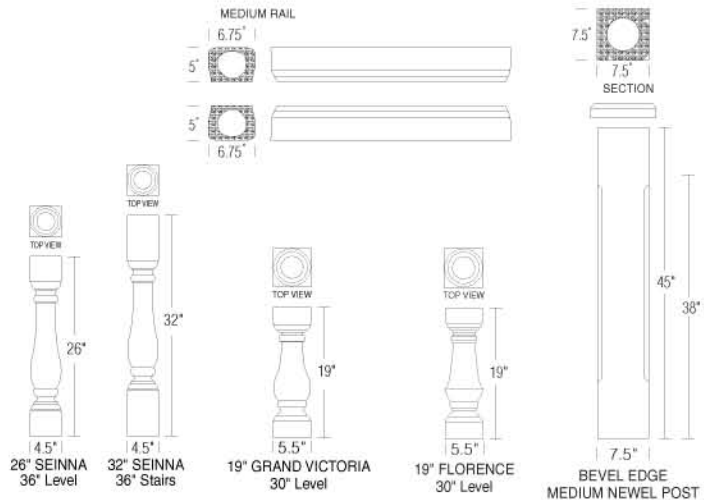

SEINNA

GRAND VICTORIA

FLORENCE

NEWEL POST



- Interior or Exterior Applications
- Maintenance Free
- Color and Textured, need not be painted
- Can be installed on wood or concrete decks, around pools and on stairways



# BALUSTRADE SYSTEMS

**L  
A  
R  
G  
E**

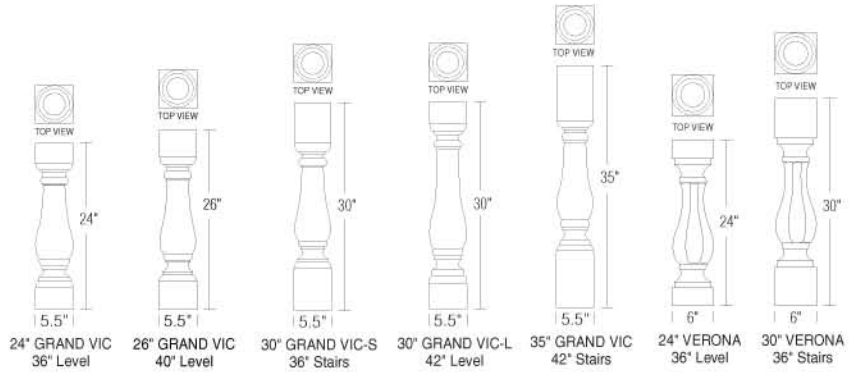

**GRAND VICTORIA**

**VERONA**

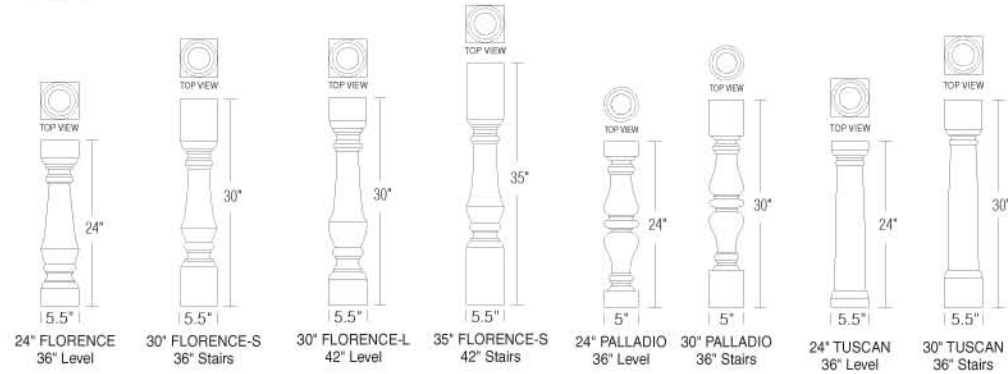
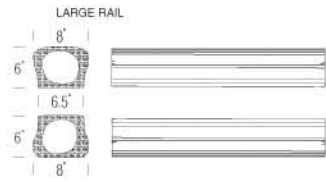

**FLORENCE**

**PALLADIO**

**TUSCAN**

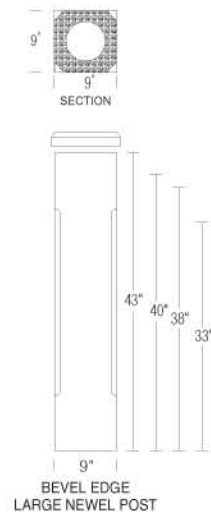
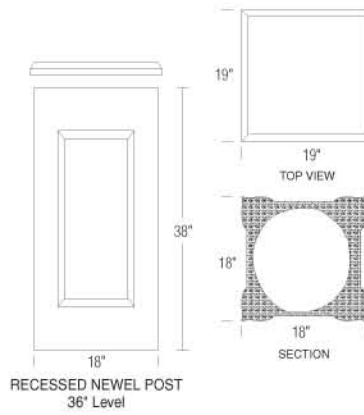
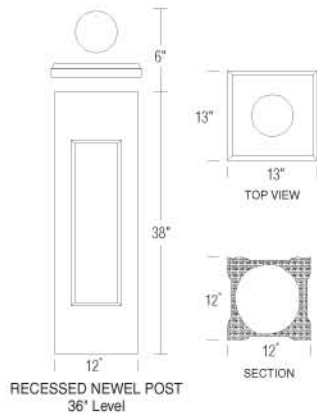
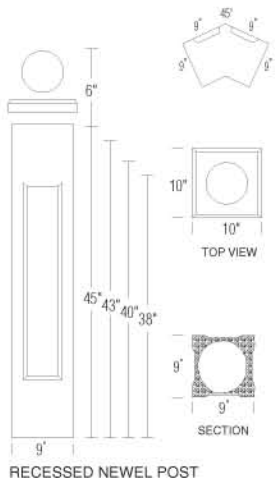

**LARGE NEWEL POSTS**